



**4X4 ACCESSORIES**

# ANNUAL GENERAL MEETING

**COMPANY PRESENTATION  
17 OCTOBER 2024**





# Welcome to our shareholders, business partners and guests.

Robert Fraser

Chairman of the Board

Andrew Brown

Managing Director

Roger Brown

Non-Executive Director

Shona Faber

Non-Executive Director

Adrian Fitzpatrick

Non-Executive Director

Karen Phin

Non-Executive Director

Andrew Stott

Non-Executive Director



**This presentation has been prepared by ARB Corporation Limited (ARB).  
The information in this presentation is current as at 17 October 2024.**

**This presentation is not an offer or invitation for subscription or purchase of securities or a recommendation with respect to any security. Information in this presentation should not be considered advice and does not take into account the investment objectives, financial situation and particular needs of an investor. Before making an investment in ARB any investor should consider whether such an investment is appropriate to their needs, objectives and circumstances and consult with an investment adviser if necessary. Past performance is not a reliable indication of future performance.**

**ARB has prepared this presentation based on information available to it. No representation or warranty, express or implied, is made as to the fairness, accuracy, completeness or correctness of the information, opinions and conclusions contained in this presentation.**

**To the maximum extent permitted by law, none of ARB, its directors, employees or agents, nor any person accepts any liability, including, without limitation, any liability arising from fault or negligence on the part of any of them or any other person, for any loss arising from the use of this presentation or its contents or otherwise arising in connection with it.**

**This presentation may contain forward looking statements that are subject to a range of risk factors and uncertainties. Whilst the statements are considered to be based on reasonable assumptions, the statements themselves and the assumptions upon which they are based may be affected by a range of circumstances which could cause actual results to differ significantly from the results expressed or implied in these forward-looking statements.**

## AGM PRESENTERS

### Robert Fraser

**CHAIRMAN OF THE BOARD – APPOINTED 30 SEPTEMBER 2022**

Robert was appointed as the Company's first Non-executive Director in 2004. He was previously Chairman of the Audit and Risk Committee and the Remuneration and Nomination Committee.

Robert has over 35 years of investment banking experience, specialising in mergers and takeovers, corporate and financial analysis, capital management, equity capital markets and corporate governance.

### Lachlan McCann

**CHIEF EXECUTIVE OFFICER – APPOINTED 5 JULY 2022**

Lachlan commenced at ARB in 2002 in Export Sales and Business Development.

Lachlan has a strong background in sales, business development and operations and oversaw the development of each international ARB operation from 2009. He served as Managing Director for ARB's Thailand business from 2008-2012 and subsequently as Chief Operating Officer until his appointment as Chief Executive Officer.

### Damon Page

**CHIEF FINANCIAL OFFICER & COMPANY SECRETARY**

Damon joined ARB as the Chief Financial Officer in 2014 and assumed the role of Company Secretary in 2019.

He was previously the General Manager Finance Executive for a large public manufacturing and exporting agribusiness with \$2.9 billion turnover. Prior to that he was an Account Director at a large audit firm.

### Dennis Horton

**DIRECTOR OF MANUFACTURING AND ENGINEERING**

Dennis commenced his career at ARB in 1996 as a Warehouse Leader.

Dennis has extensive manufacturing expertise and has been responsible for ARB's manufacturing operations since 2006. He has served as the Managing Director for ARB's Thailand business since 2015 and assumed oversight of ARB's engineering operations in July 2022.





# AGM FY24 FINANCIAL HIGHLIGHTS



**UP**  
**3.3%**  
10 YR CAGR 8.8% | **SALES REVENUE**  
**A\$693.2M**

**UP**  
**16.1%**  
10 YR CAGR 9.2% | **PROFIT AFTER TAX**  
**A\$102.7M**

**UP**  
**11.3%** | **FULLY FRANKED**  
**DIVIDENDS 69 CPS**

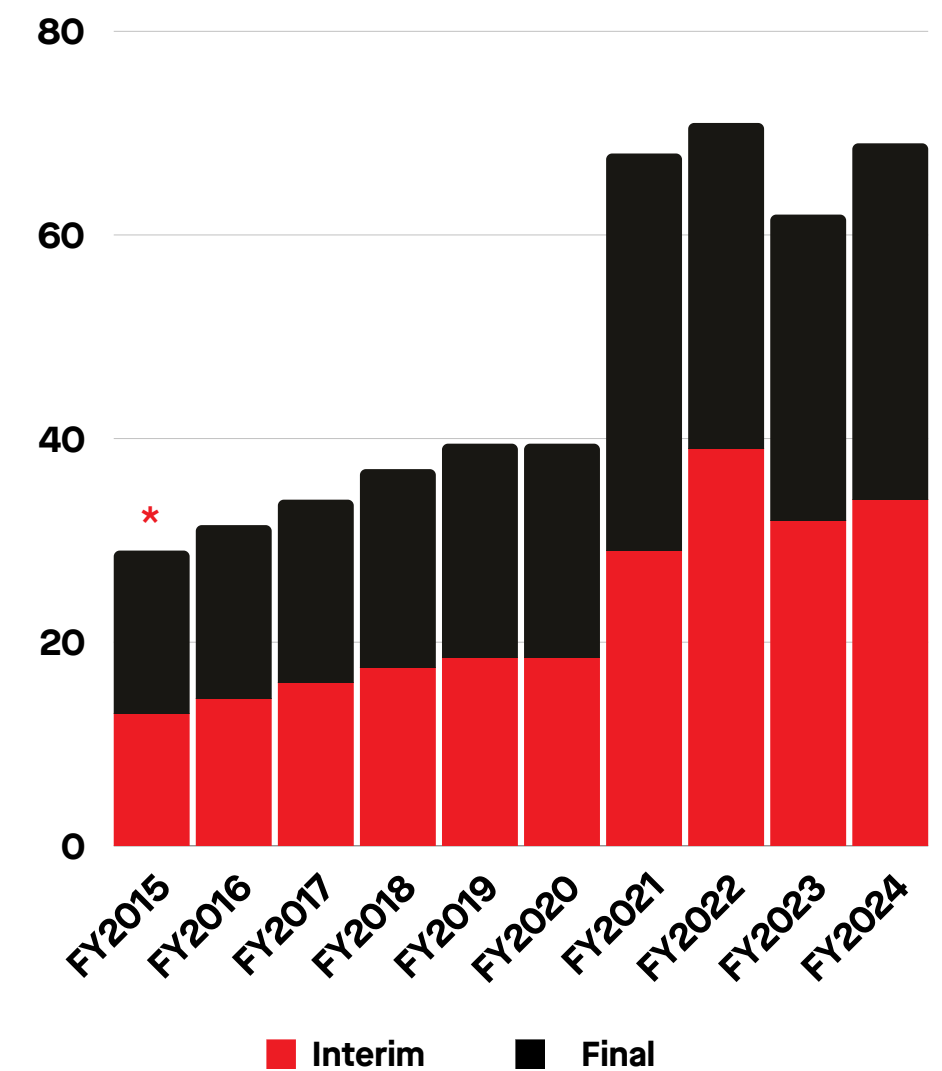
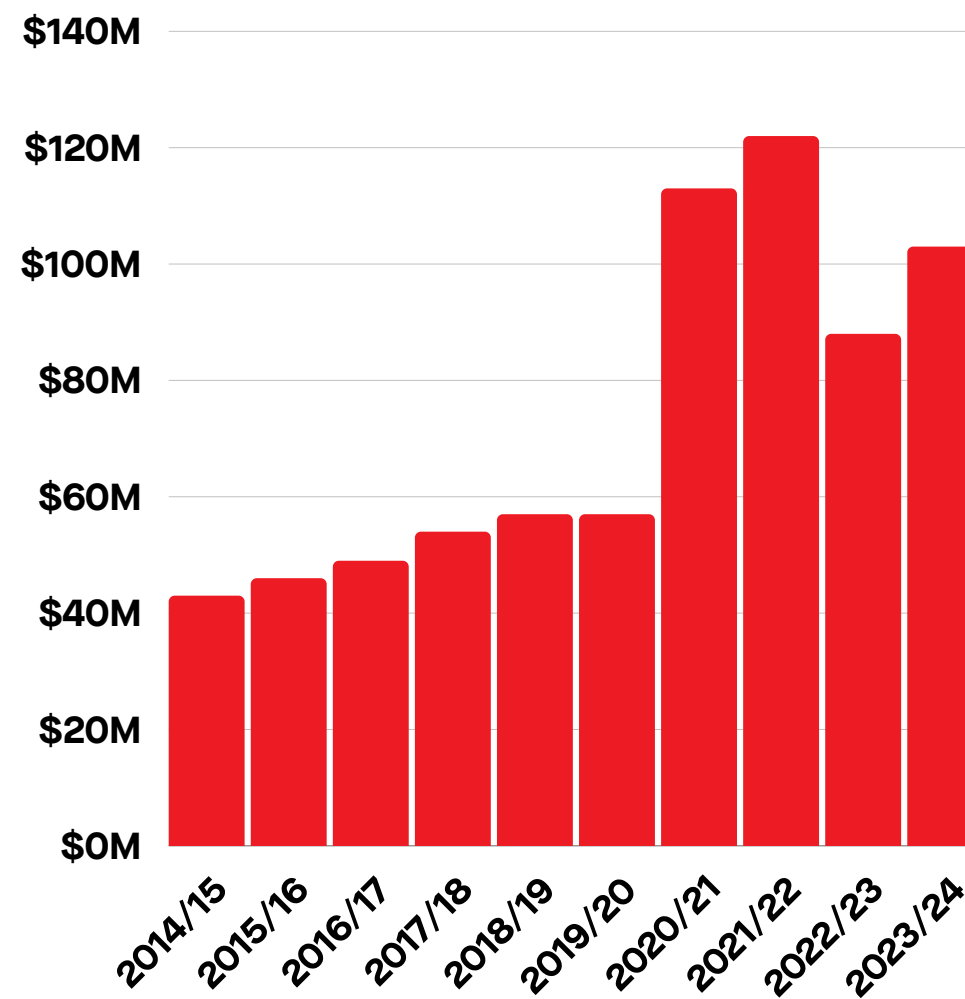
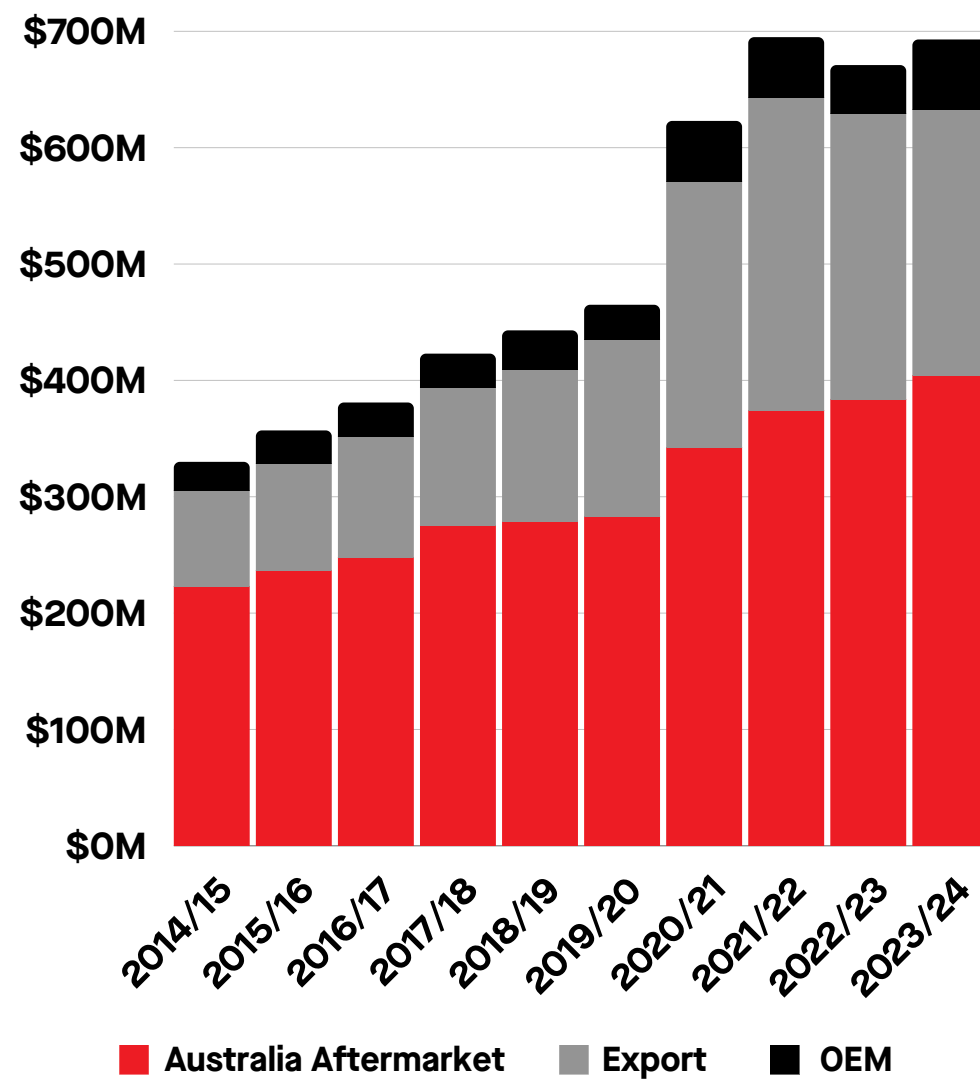

- Sales 10 year CAGR of +8.8% from FY14.
- Growth in aftermarket and OE.
- Export decline, predominantly US.

- Strong profit after tax growth driven by improved margins.
- Profit after tax 10 year CAGR of +9.2% from FY14.
- Effective tax rate comparable at 27.4% v FY23 27.5%.
- Earnings per share of 124.9 cents, up 15.7%.

- \* Excludes special dividend of 100 cps in 2015
- Fully franked interim dividend of 34 cents paid in April 2024
- Fully franked final dividend of 35 cents to be paid on 18 Oct 2024

# AGM FY24 CASH FLOW FINANCIAL HIGHLIGHTS

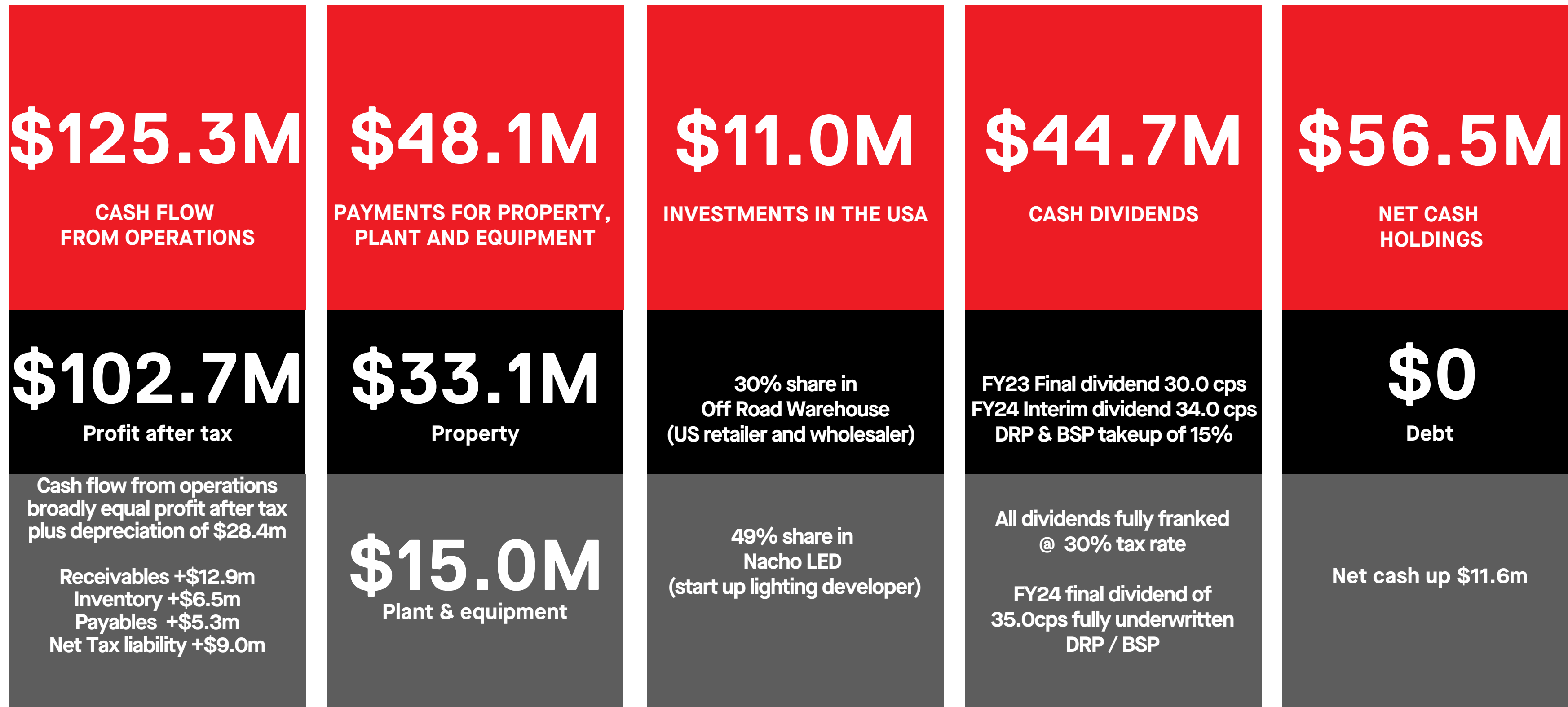

# AGM SALES REVENUE SUMMARY

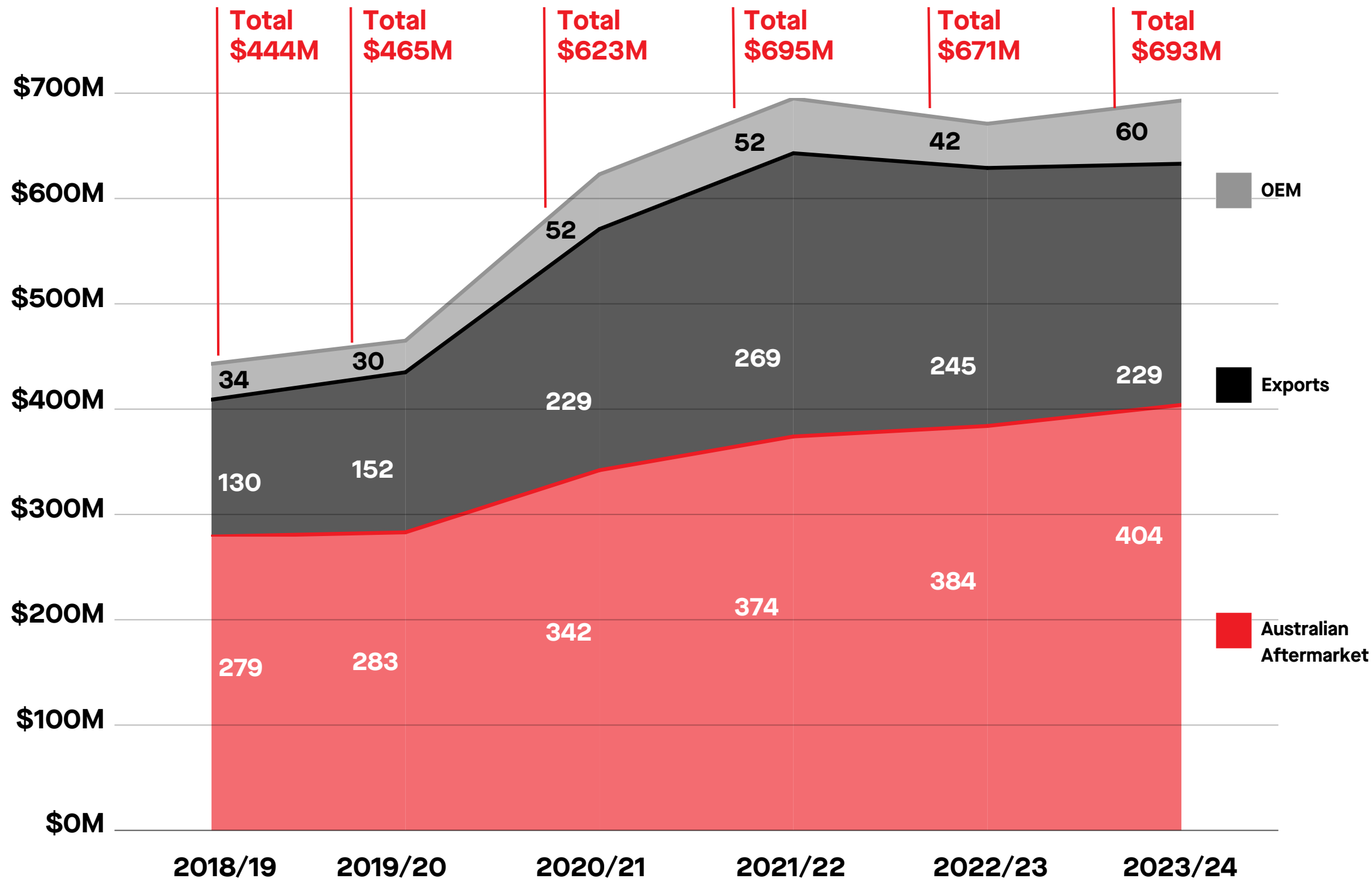

**AUSTRALIAN AFTERMARKET**  
**UP 5.4%** 58.3% of sales  
 PY: 57.2%

---

**EXPORTS**  
**DOWN 6.5%** 33.1% of sales  
 PY: 36.5%

---

**OEM**  
**UP 40.5%** 8.6% of sales  
 PY: 6.3%



# MANUFACTURING UPDATE



4X4 ACCESSORIES





## AGM MANUFACTURING UPDATE



Circa

**110,000** Square Metres of Manufacturing

### ARB MANUFACTURING TODAY

**1,300** Manufacturing Employees Worldwide

**12** Manufacturing Locations

**8** Dedicated Factories

### KILSYTH MANUFACTURING

- Welding labour shortage continues to be a constraint.
- 14 factory employees expatriated from ARB Thailand to Kilsyth.
- Continued investment and increased focus on process efficiencies.
- Increased focus on robotics skill and investment at Kilsyth.
- Increased production output - fabricated products.
- Priority on speed to market for key new models.
- Completed a significant number of critical pilot runs.
- Commenced upgrades to factory amenities areas.

### SMARTBAR MANUFACTURING

- Challenging labour shortages in Lonsdale, Adelaide.
- Significant number of new automotive products introduced.
- Expanded range of non-automotive products.
- Developed and committed to a robotic trimming cell.

### PROFORM MANUFACTURING

- Improved demand for back of ute products in H2 FY24.
- Increased production output in H2 FY24.
- Commenced supply of OEM bedliner for AU Toyota Hilux.
- Improved speed to market through tooling developments.





## AGM MANUFACTURING UPDATE



### THAILAND MANUFACTURING

- Appointed new Managing Director.
- Significant investment in plant & new equipment.
- Increased investment in automated manufacturing.
- Outsourced bottleneck processes.
- Increased manufacturing output.
- Expanded direct and indirect labour teams to support growth.
- Commenced manufacture of products for Toyota Motors North America.
- Refined Earth Camper manufacturing to improve quality consistency.



Ford Ranger with Summit Mkii bar in front of ARB Thailand Factory 4

### MANUFACTURING ADVANCEMENTS

- Now a tier 1 supplier to Toyota Motors North America.
- Advanced requirements to control supplier and manufacturing quality and achieve delivery on time.
- Added headcount to engineering, procurement and quality teams.
- Developed more sophisticated in-house processes to define quality requirements and control quality outcomes.
- Implementing more advanced jigs and fixtures.
- Utilising automation to control quality and drive efficiency.
- Reaching new levels of manufacturing sophistication.







## CAPITAL EQUIPMENT

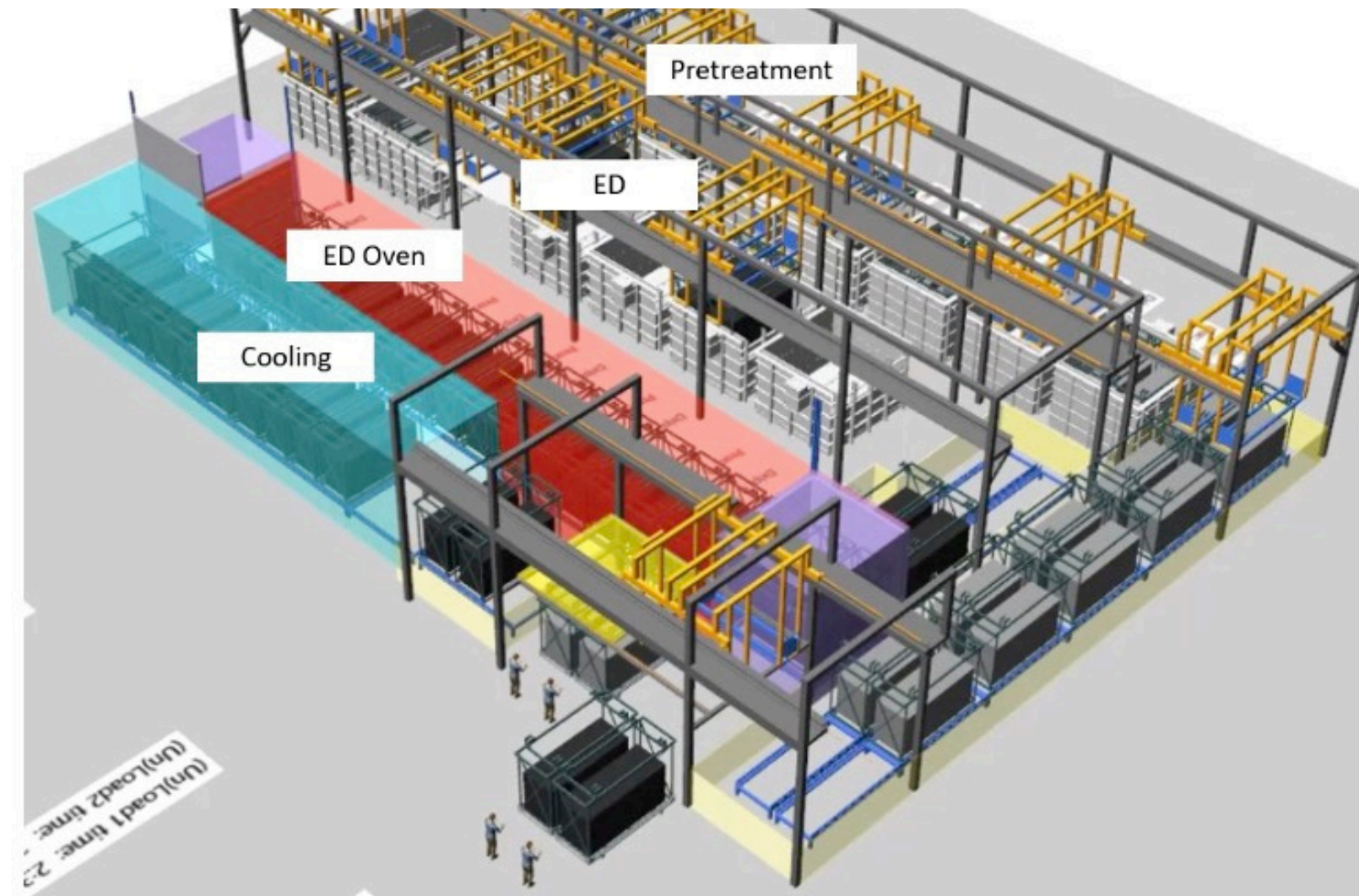

### KEY INVESTMENTS FY24

- Added 3 x robotic welding cells.
- Lathes, mill and dyno for suspension products.
- Various other machines to expand capacity.

#### Key investments underway

\$9.2 million capital equipment on order, including:

- 6 x robot cells.
- 4 x sheetmetal press brakes.
- 2 x sheetmetal laser cutters.

### ARB THAILAND COATING LINE

- High output E-coat and Powder-coat line.
- Improved product protection against corrosion.
- Higher degree of coating consistency through automation.
- Increased production efficiency.
- Capacity to complete all current volumes in-house.
- Bring outsourced work in-house.
- Capacity can be expanded in the future.
- Work to commence Q2 FY25 and complete Q3 FY26.



# AGM MANUFACTURING - EARTH CAMPER



## RECAP

- Launched 2023.
- 7 years in development.
- Unique styling and design with ARB DNA.
- Tow anywhere, go anywhere camper.
- Recreational Vehicle with over 3,500 components

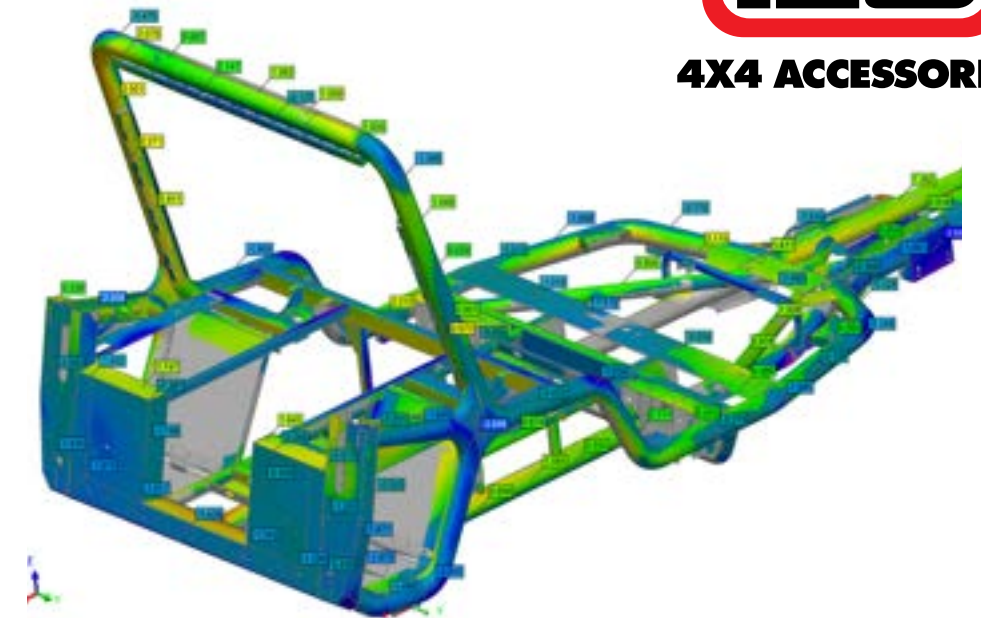
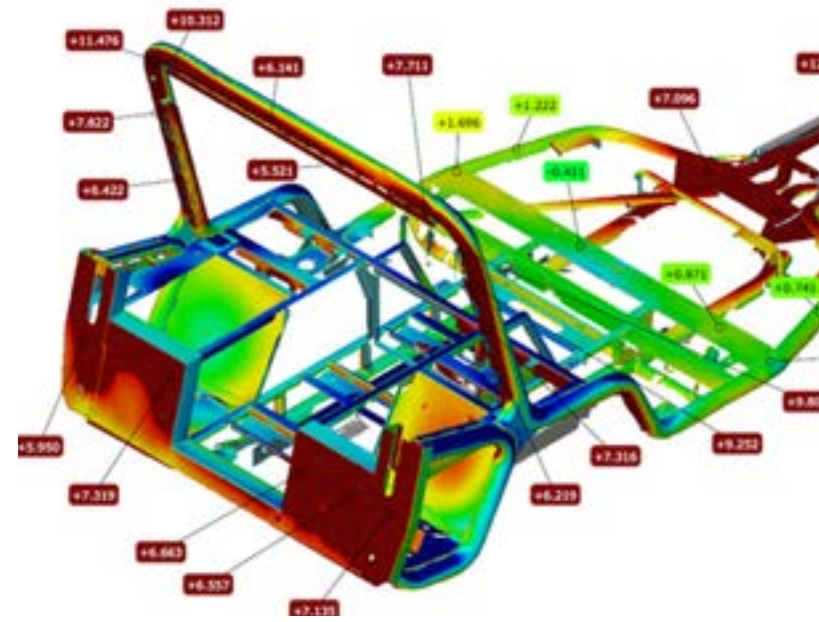

## AFTER LAUNCH

- Positive customer feedback, it is a great product.
- Some issues with component design and build quality.
- Listened to feedback.
- Engineering team redesigned and improved the product.
- Production processes refined.
- Investment in testing and inspection equipment.
- Additional in-field testing completed.

## WHAT'S NEXT?

- In-field campers being upgraded to current specs.
- Refined production underway at a steady rate.
- Delivering upgraded latest spec campers from Thailand now.





# ENGINEERING UPDATE



4X4 ACCESSORIES





### INVESTMENT IN INNOVATION & NEW PRODUCT DEVELOPMENT REMAINS A CRITICAL PILLAR OF SUCCESS FOR ARB

- 95 engineers in Australia and New Zealand, up from 82 last year.
- 47 engineers in Thailand, up from 31 last year.
- Expanded OEM engineering team.
- Expanded ARB product R&D teams.
- Expanded production engineering teams.
- In addition, procurement and quality engineering teams have increased.
- Expanding Kilsyth engineering office and workshop areas.

---

### USA & THAILAND BASED ENGINEERING TEAMS

- New R&D engineering teams will be developed for both the USA and Thailand.
- Localisation and efficiency of design are critical to support growth strategies.
- Geographic expansion of engineering will support speed to market and regionally relevant content.
- Global engineering expansion will help AU engineering focus on the fast and high-quality execution of AU content.



Ford 150 with new ARB Zenith bar and Nacho lights, in front of the engineering centre at ARB head office in Kilsyth



### USA ENGINEERING & DEVELOPMENT

- ARB continues to invest in design and development for key US platforms.
- Air freight of new Toyota Tacoma and Toyota LandCruiser (Prado 250) to Australia to expedite new product development for these platforms.
- Approved a new engineering centre in the USA for localised product development. Recruitment for engineers has commenced.
- ARB anticipates its US R&D facility to launch in December 2024.
- This is a key initiative to support product range and speed to market in USA.

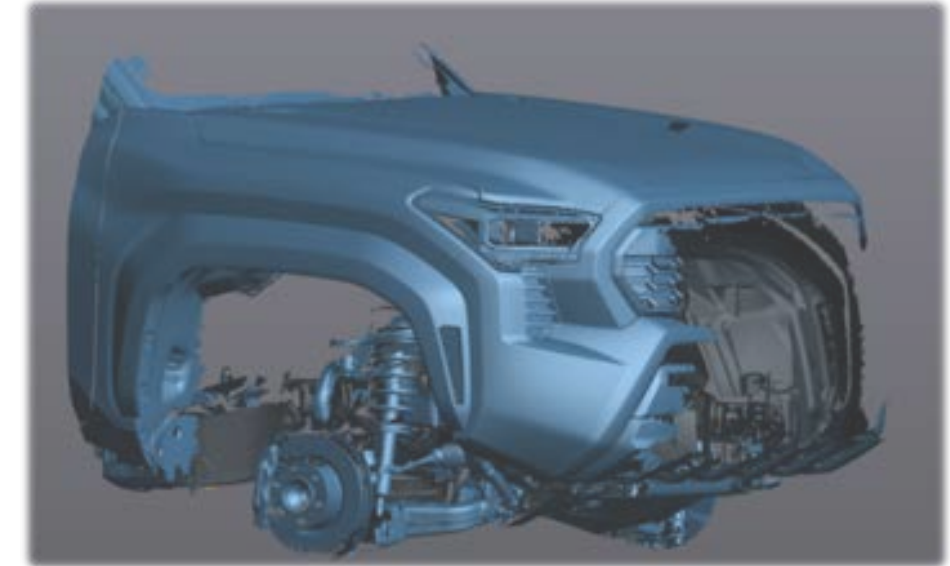

TOYOTA TUNDRA



TOYOTA LANDCRUISER 250 (PRADO)



TOYOTA TACOMA





4X4 ACCESSORIES

# AUSTRALIA



# AGM AUSTRALIAN NEW VEHICLE SALES V FY23



## NUMBER OF VEHICLES SOLD ('000S)

### PERCENTAGE CHANGE FY24 V FY23

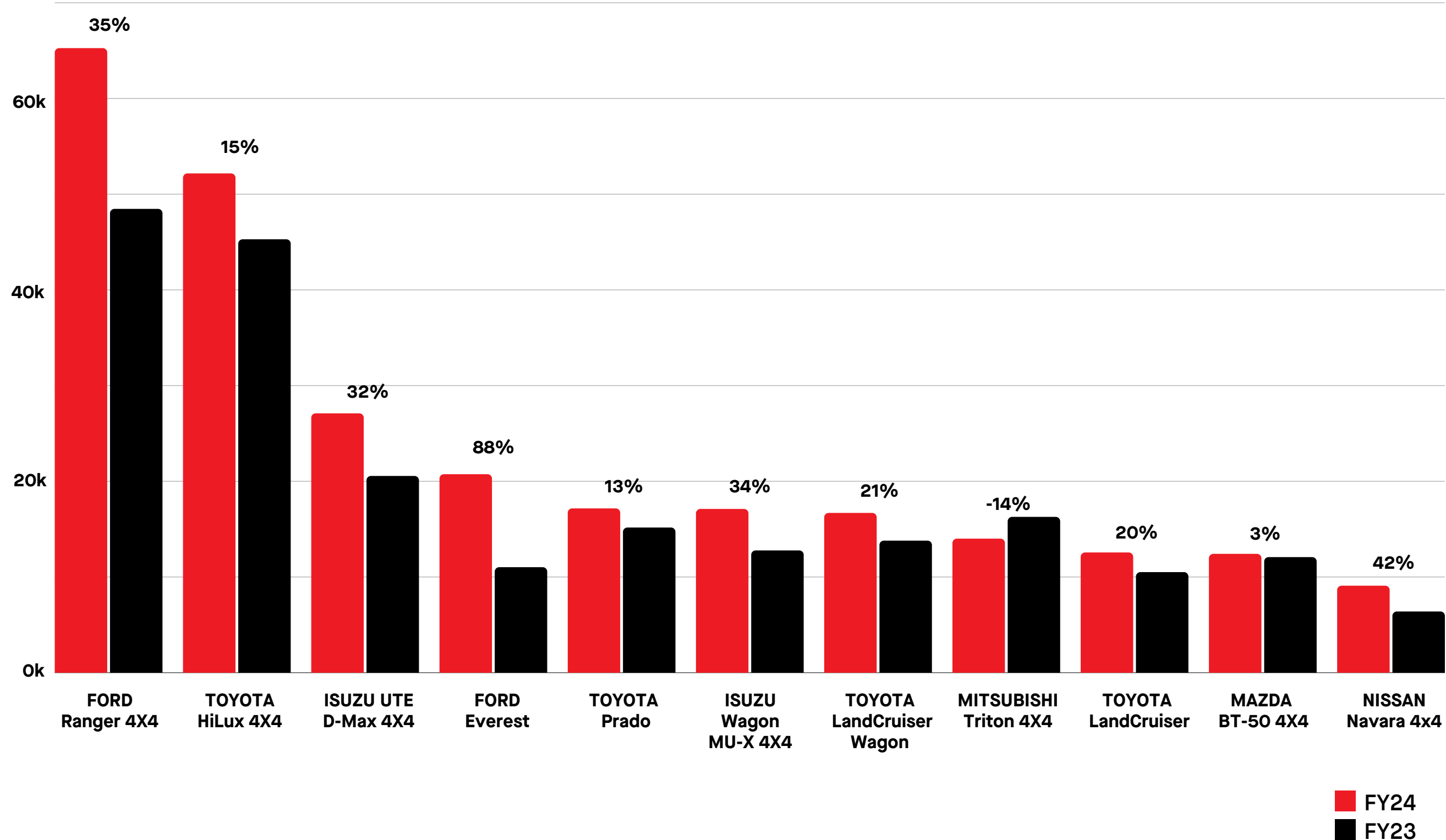

Strong new vehicle sales for core ARB models in the financial year.

Australia's continued appetite for 4x4 pick-up vehicles highlighted in registration growth. Most notably Ford Ranger, Toyota HiLux and Isuzu D-Max.

Ford Everest growth coupled with the Ford License Accessory program has benefited ARB.

LandCruiser Prado, an important platform for ARB, struggling through a model change at present.

New vehicle sales have had a slow start to the new financial year.



## AGM AFTERMARKET RETAIL STORES



**74** ARB STORES  
IN TOTAL  
NATIONWIDE

FLAGSHIP ARB STORE  
DEVELOPMENTS DUE IN FY2025

**6** INDEPENDENT  
FLAGSHIP  
UPGRADES

**4** INDEPENDENT  
FLAGSHIP - ALL  
NEW SITES

**3** CORPORATE  
FLAGSHIP  
UPGRAGES

**1** CORPORATE  
FLAGSHIP - ALL  
NEW SITE

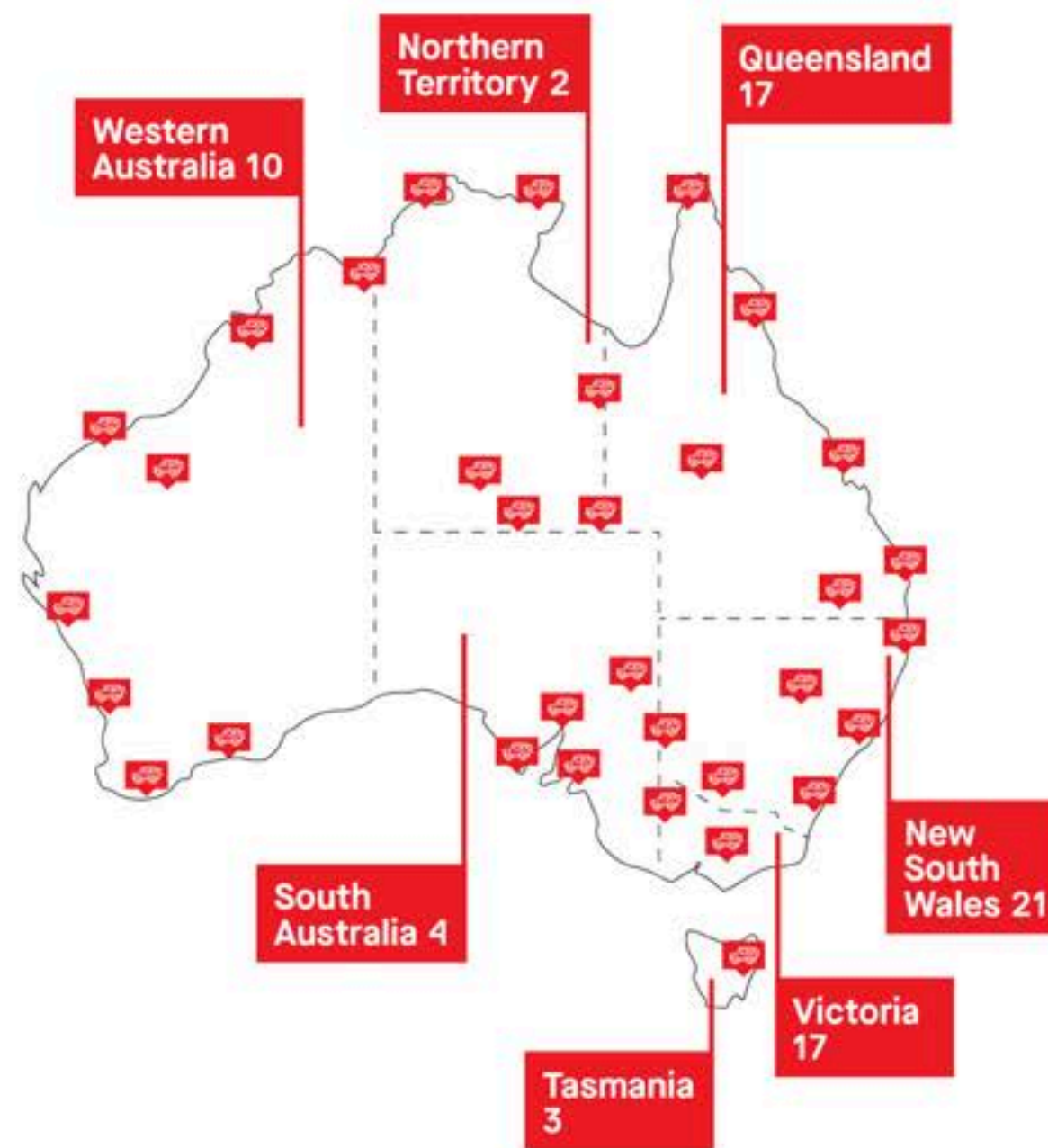

The Company's flagship store program continues to develop with deep investments being made by the Company and independent ARB store owners.

The store development program includes both refurbishment of existing locations and development of all new locations including the conversion of ARB stockists to Flagship partner stores.

ARB is actively seeking new development sites in focused metropolitan and regional areas nationally.

The resources to increase the pipeline of new store developments beyond FY25 remain a focus.

**Australian Aftermarket remains strong representing 58.3% of ARB sales, up 5.4% on FY23.**

# AGM NATIONAL SALES NEW STORE UPDATES



## NEW FLAGSHIP STORES IN FY25

ARB GRIFFITH, NSW

ARB NEWCASTLE, NSW

ARB MIDLAND, WA

ARB ROCKINGHAM, WA



## GRAND OPENING MORNINGTON, VIC

Successful grand opening event on 12 October 2024.



## MITTAGONG, NSW

- All new site being developed by the current independent store owner of ARB Wollongong, NSW.
- Fantastic opportunity for growth in Southern Highlands with proximity to Bowral and Moss Vale.
- Estimated opening FY2025.



## BUNDABERG, QLD

- Store opened 9 September 2024.
- Positive trading results and customer feedback since opening new site.



## KILSYTH, VIC

- Open date - December 2024
- Head office site, important for the brand, employees and corporate customers.



# AGM NATIONAL SALES PERFORMANCE



## MARKET UPDATE

The Australian Aftermarket performed well in FY24 with sales up 5.4%. Retail sales in corporate stores remained relatively flat. Sales to independant stores and stockist showed positive growth, while sales to motor vehicle dealerships and fleet companies grew strongly.



## ENGAGEMENT

- Fitter turnover continues to trend positively. The Company now has a record number of fitters.
- Fitter turnover levels vary greatly from State to State: in VIC/TAS turnover is at an all time low, NSW and WA continue to present challenges.
- Fitter pathway and fast-track induction programs are progressing well.
- Experienced workshop fitters with 3+ years' tenure are rising.



## PERFORMANCE

- Workshop performance is directly correlated to tenure and product mix. Higher volumes of fleet work through the workshops have improved efficiency.
- Fast Track induction program does slow output as new fitters get up to speed.
- Skill development and training via ARB-U remains a business focus.

TOTAL 4X4 TECHNICIANS

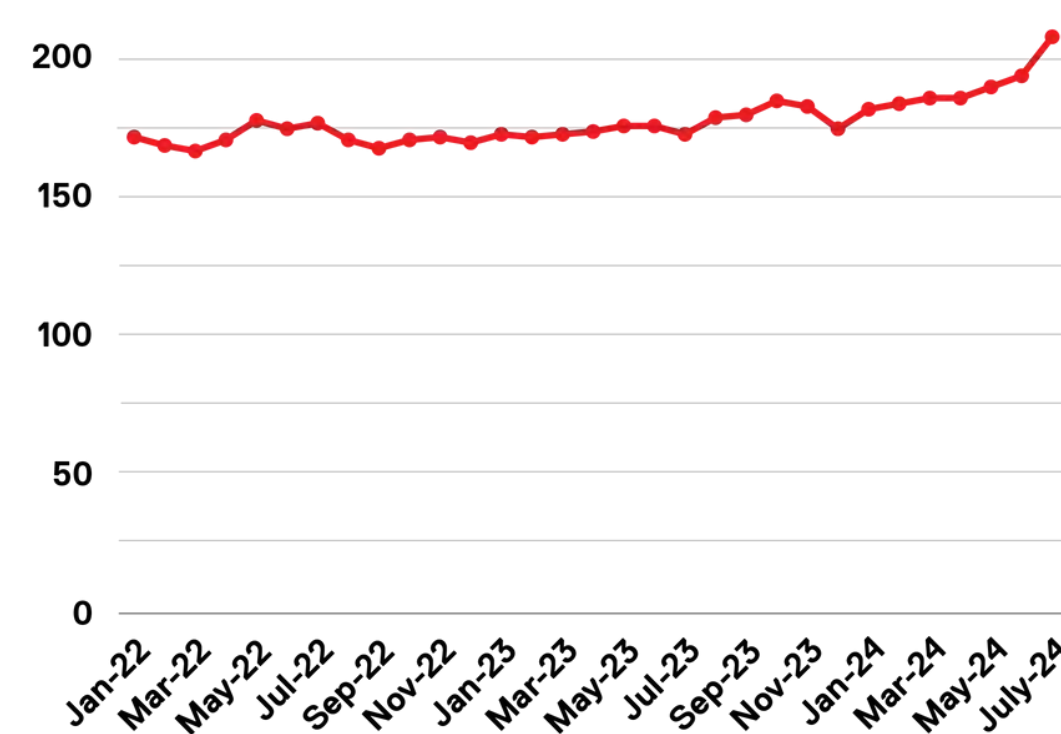

4x4 TECHNICIAN TENURE

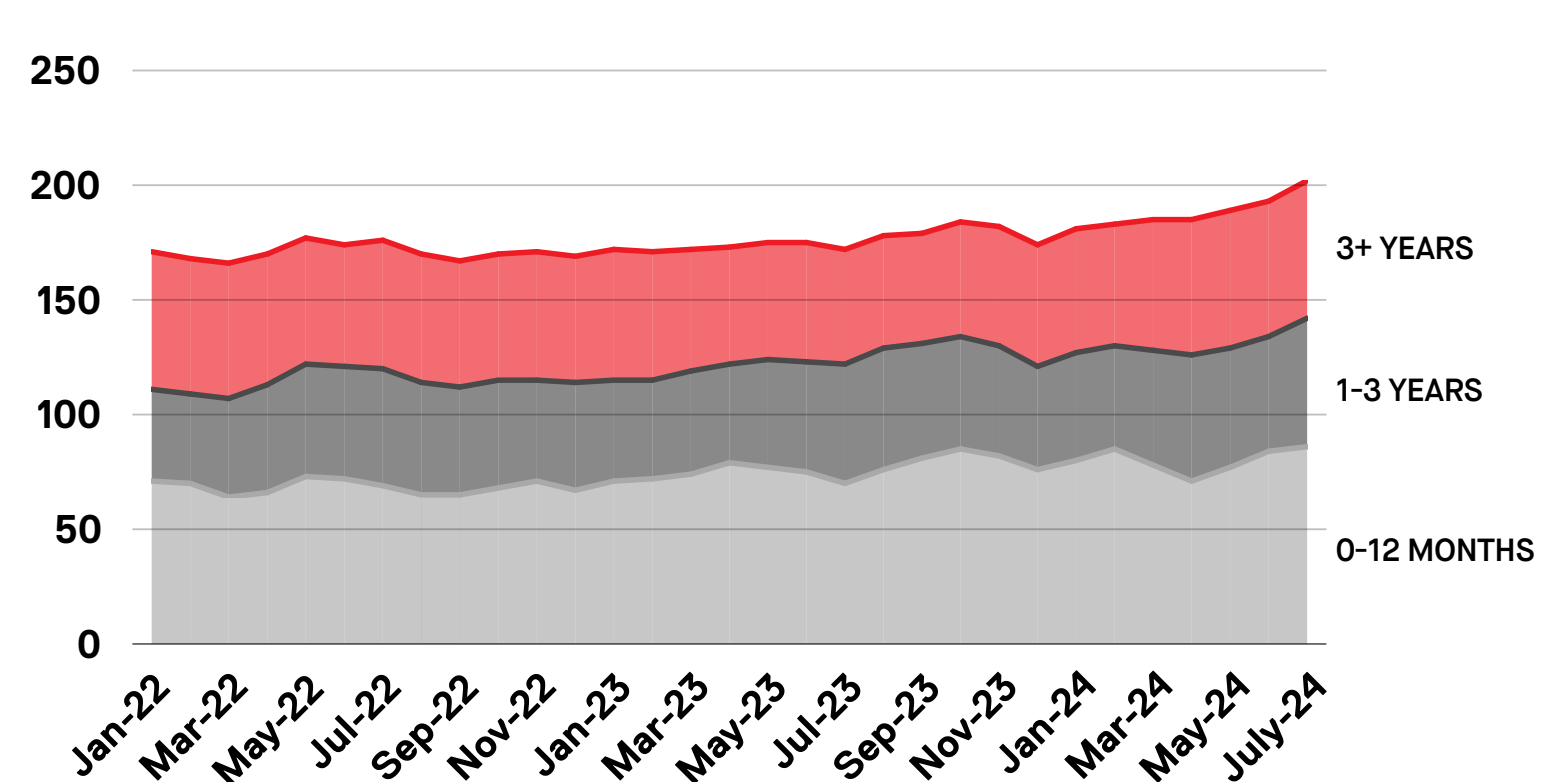



# AGM DISTRIBUTION TO MARKET - FLA PARTNERSHIP

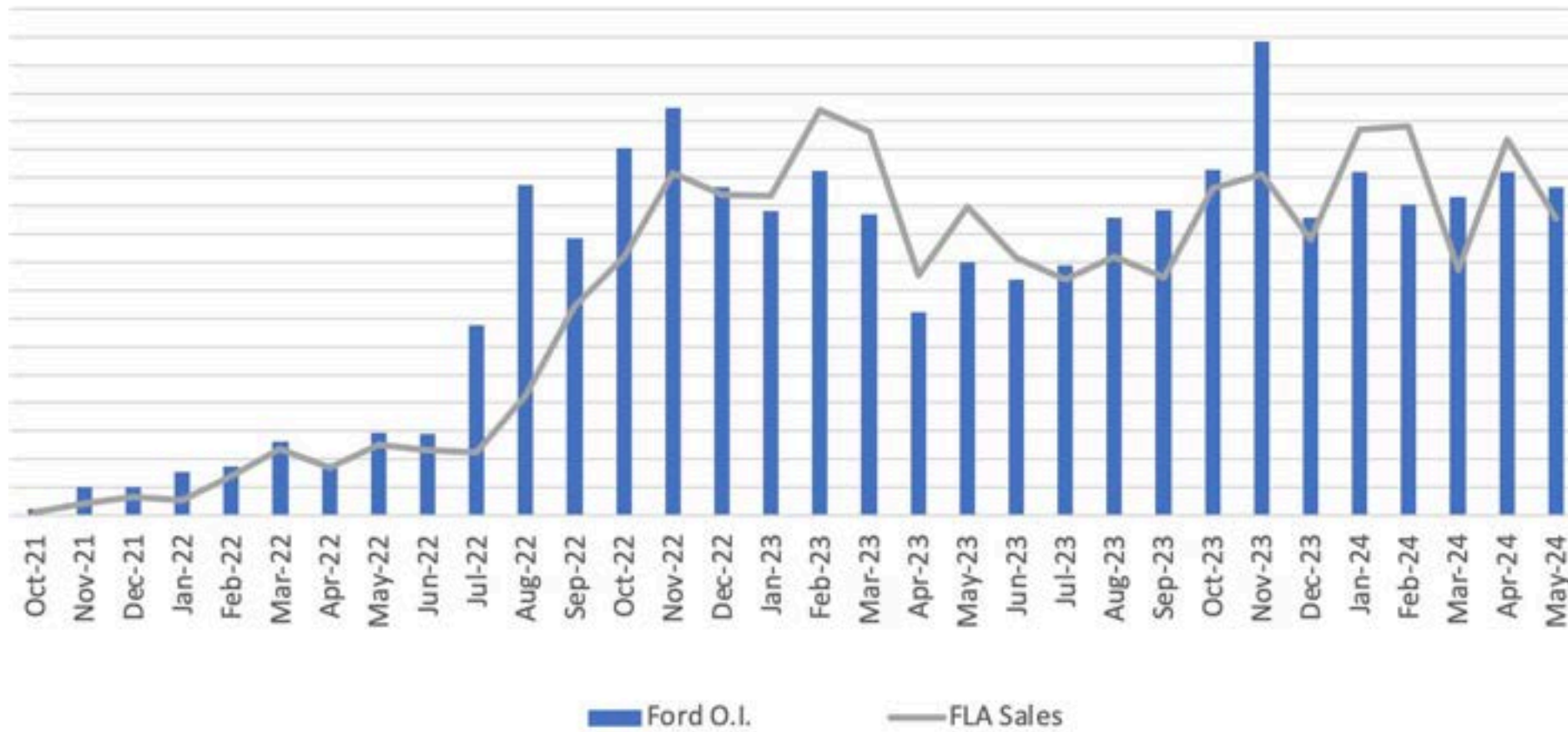

- Ford Licensed Accessory program sales and order intake continue to trend positively.
- Dealerships showing increasing engagement in the FLA program.
- Ford and ARB working on approvals for 10 new product lines to include in the program.
- FLA sales in markets such as New Zealand, Europe, Middle East and Thailand continue to grow.
- Ford and ARB in negotiation to extend the current FLA contract for a further 5-years.



Finance your new Ford and ARB Accessories with MyFord Finance

Enquire within for more details.



Optional accessories shown. Finance to approved applicants only (excluding government, fleet and rental buyers). Finance is provided by Allied Retail Finance Pty Ltd trading as MyFord Finance ABN 21 600 850 850. Australian credit licence AUC21. Ford, the Ford Oval, MyFord Finance and MyFord are registered trademarks of Ford Motor Company and are used by Allied Retail Finance Pty Ltd ABN 21 600 850 850. Australian Credit Licence AUC21 pursuant to a licence.



Finance your new Ford and ARB Accessories with MyFord Finance

Enquire within for more details.



Optional accessories shown. Finance to approved applicants only (excluding government, fleet and rental buyers). Finance is provided by Allied Retail Finance Pty Ltd trading as MyFord Finance ABN 21 600 850 850. Australian credit licence AUC21. Ford, the Ford Oval, MyFord Finance and MyFord are registered trademarks of Ford Motor Company and are used by Allied Retail Finance Pty Ltd ABN 21 600 850 850. Australian Credit Licence AUC21 pursuant to a licence.



Ford and ARB have announced a new finance program to support the FLA program, which will be promoted through both Ford and ARB channels.

**Ford Licensed Accessory program continues to grow, backed by strong corporate collaboration.**





4X4 ACCESSORIES

# INTERNATIONAL







**4X4 ACCESSORIES**

NEW ZEALAND





ARB EXPORT SALES BY REGION (A\$ Millions)

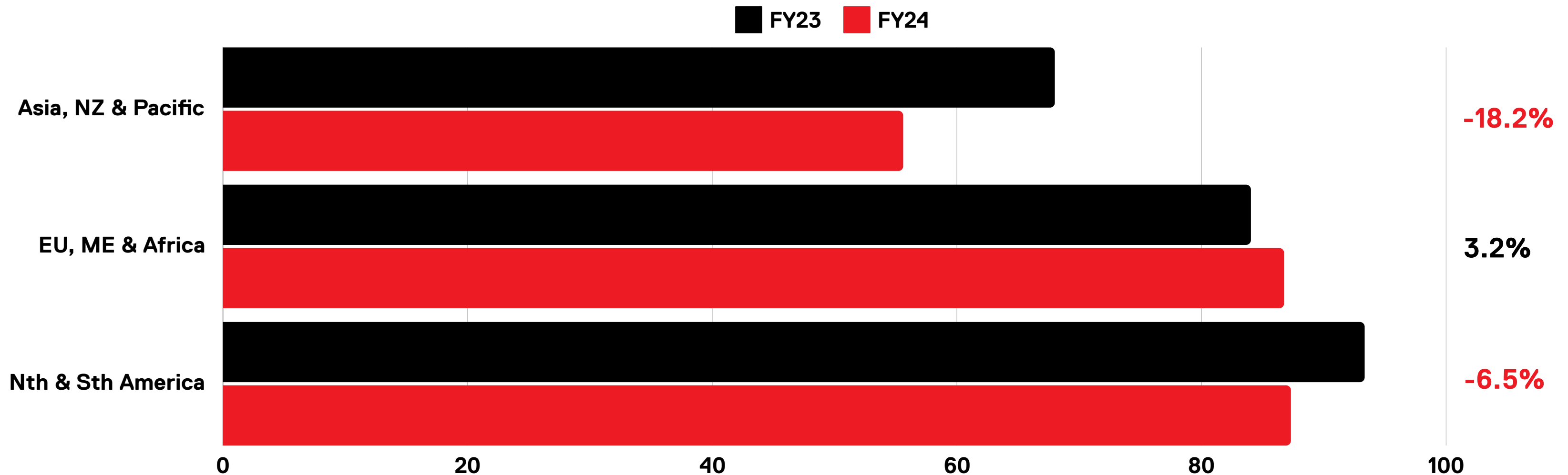

Export business recorded a net decrease of 6.5% in FY24. Sales decreased by 13.6% in H1 FY24 but improved with slight growth in H2.

Truckman continued its positive results in H2 FY24, recording strong revenue and profits in line with a recovering vehicle market.

Weakness through Asian markets, particularly China, compounded the negative result through Asia Pacific. Low consumer confidence and weak new vehicle sales impacted revenue.

Export sales represents 33.1% of ARB sales.







# AGM USA 4WP AND ORW LOCATIONS



**Combined 53 retail stores**  
**Combined 500+ employees**  
**50% ownership**

| State        | Off Road Warehouse | 4 Wheels Parts | Total     |
|--------------|--------------------|----------------|-----------|
| Arizona      | 2                  |                | 2         |
| California   | 5                  | 17             | 22        |
| Colorado     | 1                  | 4              | 5         |
| Florida      |                    | 8              | 8         |
| Georgia      | 1                  |                | 1         |
| Hawaii       |                    | 1              | 1         |
| Nevada       | 2                  | 2              | 4         |
| Oklahoma     |                    | 1              | 1         |
| Texas        |                    | 9              | 9         |
| <b>Total</b> | <b>11</b>          | <b>42</b>      | <b>53</b> |

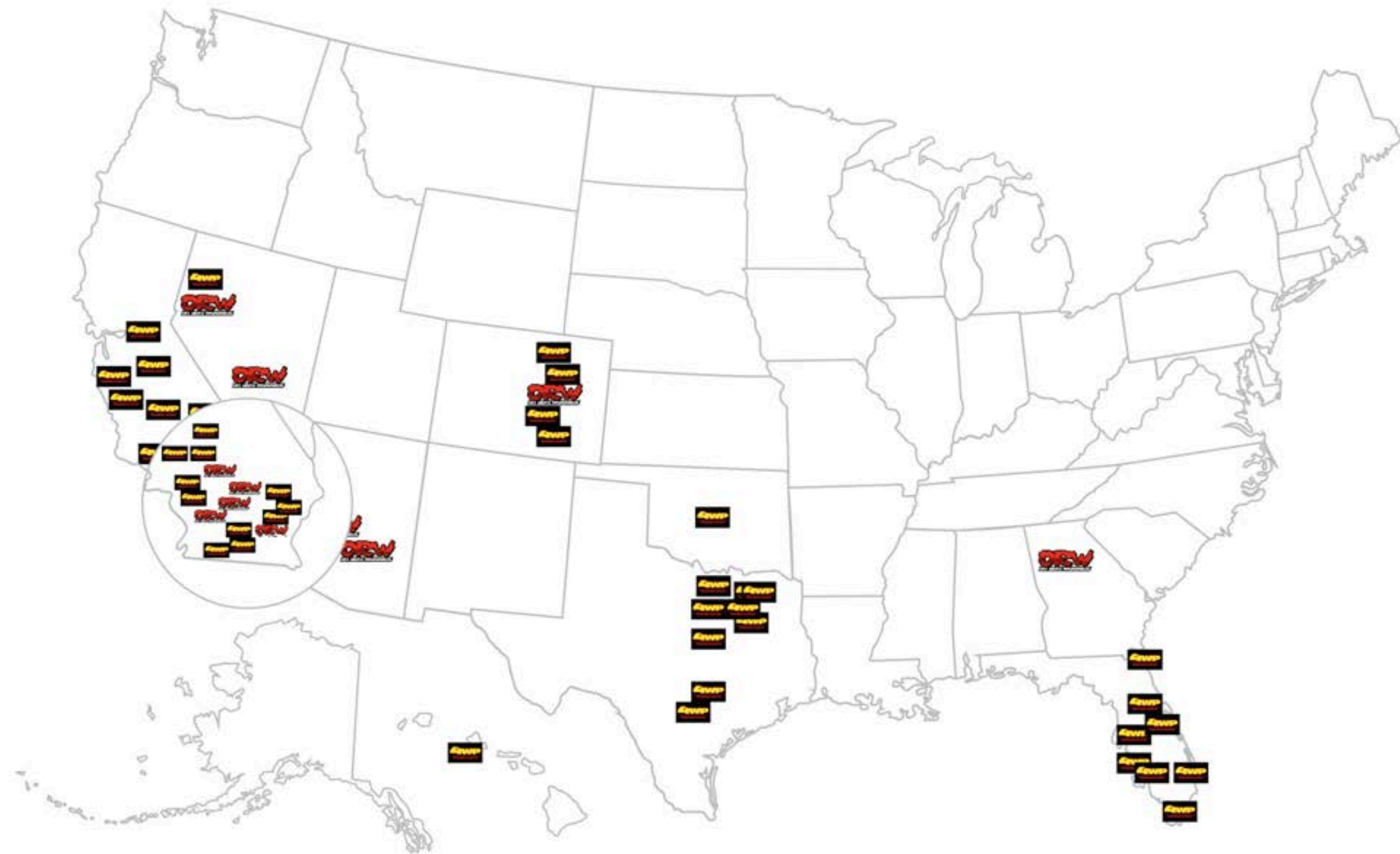









## AGM 4 WHEEL PARTS



# 4 WHEEL PARTS ('4WP') AT A GLANCE

4WP is a leading omni-channel retailer and installer of aftermarket parts and accessories in the US to the growing light truck and off-road SUV segment.

## LEADING RETAILER OF AFTERMARKET OFF-ROAD VEHICLE PARTS

-  Unique omni-channel platform with a strategic retail footprint and high-quality e-commerce platform.
-  Strong trust and brand value developed over decades with the off-road enthusiast community.
-  Complete portfolio with over 18 product categories and +45,000 SKUs covering most off-road part needs.
-  Storefronts serve as both a community hub for enthusiasts and a resource for customers seeking tailored expertise.
-  Seamless integration between stores & website enables real-time part availability.
-  All products are available to be installed in-store, which few competitors can replicate.

## 42 STRATEGICALLY LOCATED STORES

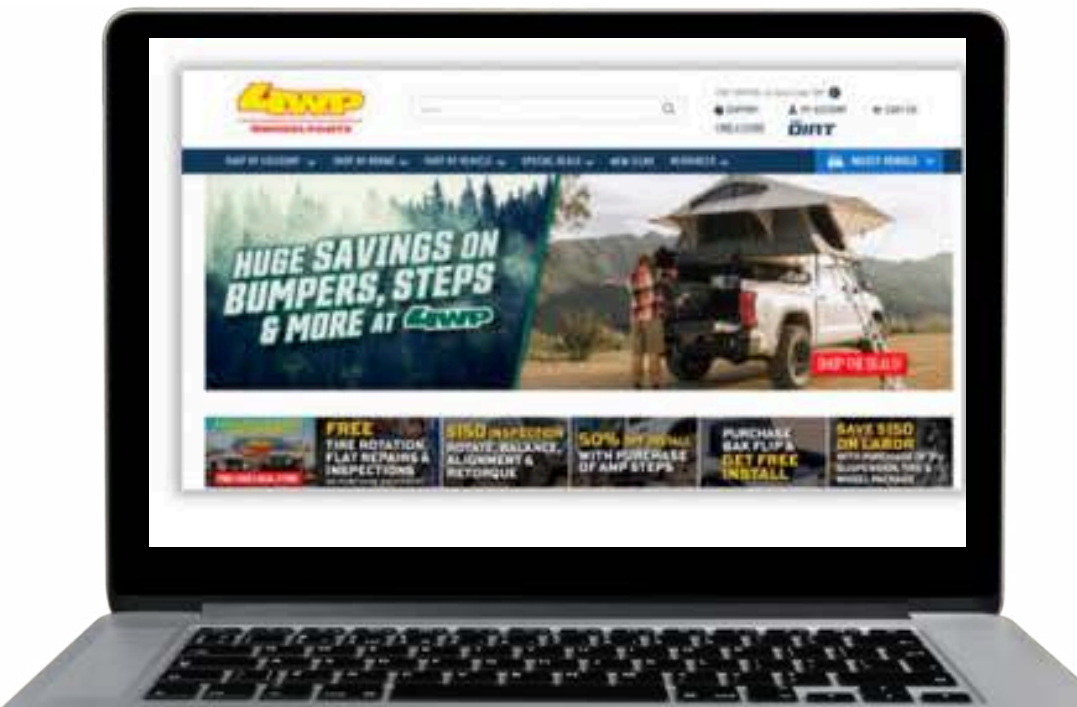

### RETAIL

~ US\$155M  
LTM Sales

180k+  
Annual  
Transactions

42  
Retail  
Locations

US\$920+  
Average  
Order Value



### E-COMMERCE

~ US\$45M  
LTM Sales

140k+  
Annual  
Transactions

30M+  
Website visits  
per year

US\$385+  
Average Order  
Value



# AGM USA 4WP AND ORW LOCATIONS

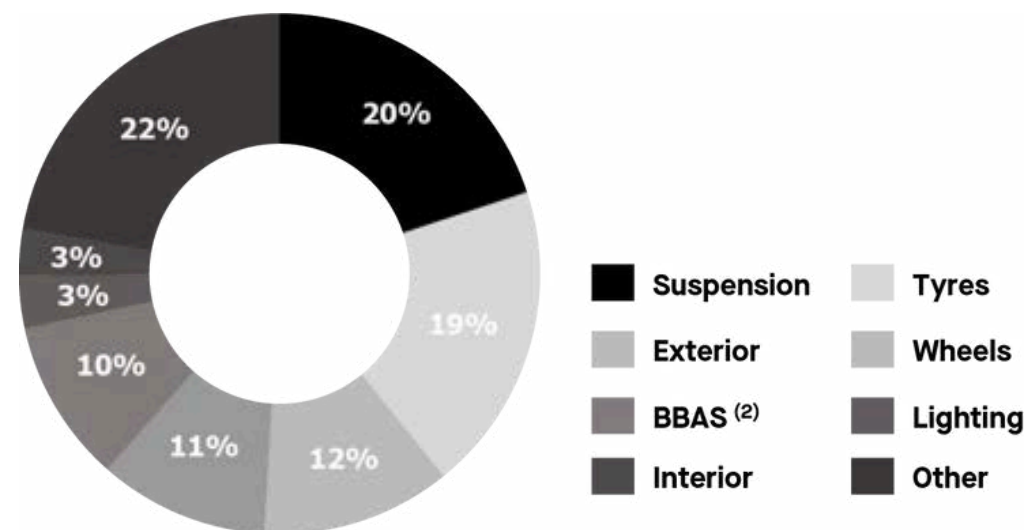

## SERVING ALL KEY MAKES



**100% Focused on the Growing Jeep, Truck and SUV Aftermarket**

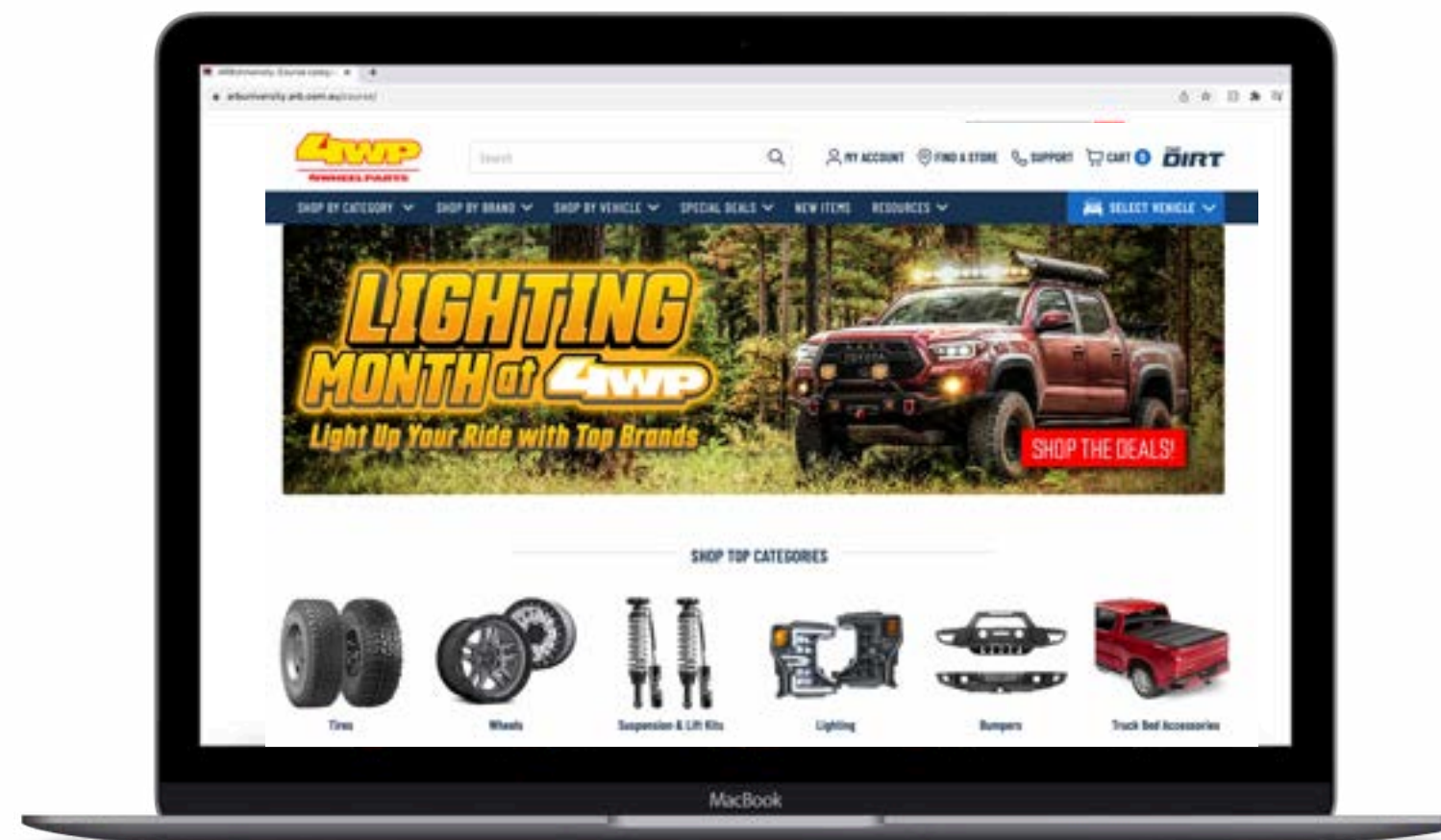

- ARB will move from 30% ownership in ORW to 50% ownership. Acquisition value for 4WP including associated IP and digital assets is US\$30M. Approximately US\$16M of stock.
- ARB will provide ORW with US\$10M interest bearing loan which will not be fully drawn at sale.
- Sale will close 18 October 2024 and trade under ORW management from 21 October 2024 .
- Business acquired with a court ordered free & clear sales order which limits liability.
- 394 employees coming across as a part of the acquisition (15% of 4WP team not offered ORW employment contracts).
- Some software and IT and various service contracts will not be transferred to lower future operating costs.
- ARB retains rights to extensive in-store merchandising, marketing and employee training.
- ARB will continue equity accounting the financial results of ORW following the 4WP acquisition.



# AGM POISON SPYDER



## POISON SPYDER OPPORTUNITY AT A GLANCE

Poison Spyder is a well-recognised aftermarket brand among the Jeep enthusiast community, known for its quality, adhering to rigid standards for design, function & style.

## HARDCORE PARTS FOR Hardcore ENTHUSIASTS

- Manufacturer of aftermarket Jeep bumpers, side steps and other exterior functional product.
- The brand is known for a function-first approach, enabling excursions through the most extreme 4x4 trails and obstacles.
- Complemented by an instantly recognisable style that consumers still love today.



### REPRESENTATIVE SALES BY PRODUCT CATEGORY

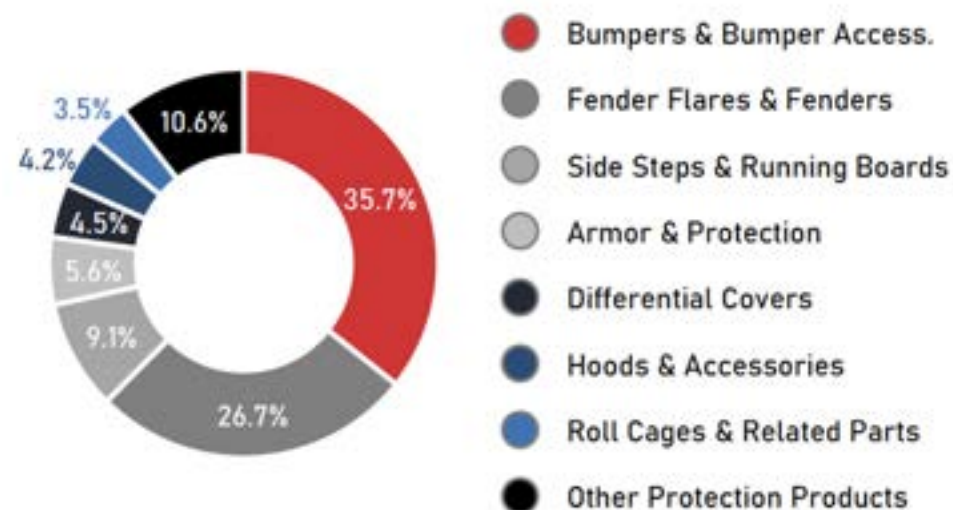

### REPRESENTATIVE SALES BY CHANNEL

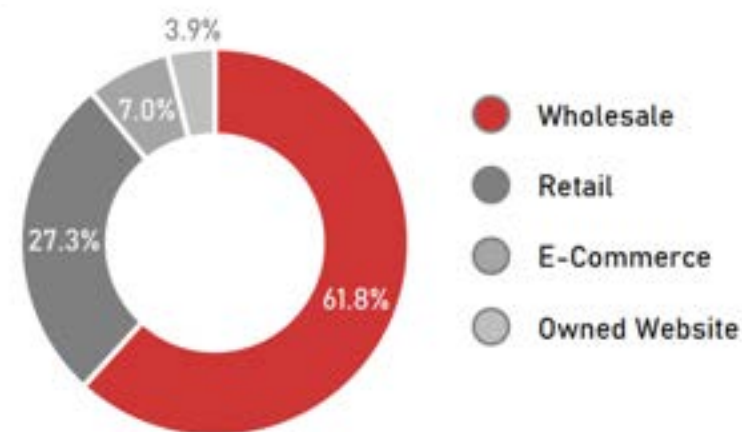

## POISON SPYDER SITUATION OVERVIEW

Contained in Poison Spyder's assets/IP are:

- Over 500 SKU engineering drawings and designs
- ~\$700k of SKU tooling assets
- Very strong brand

- Acquisition of Poison Spyder for US \$1M by ARB USA. Iconic brand in the US Jeep centric aftermarket.
- At its peak Poison Spyder product sales were \$15M in 2017.
- Largely fabricated products targeting the rock crawling enthusiast market. Synergistic to ARB manufacturing.
- Poison Spyder products merchandised in all 4WP stores today.
- Complementary to ARB USA's engineering plans. Poison Spyder range expansion.



## SALES



- Market conditions in the USA remain challenging, with industry wide headwinds both in new vehicle sales and the automotive aftermarket industry.
- Despite this, ARB USA continues to invest in brand development, promotional initiatives and distribution capability across the USA.
- ARB USA sales and marketing teams are well progressed in their planning for the 4 Wheel Parts opportunity.

## DISTRIBUTION EXPANSION



- In anticipation of expansion of OEM and aftermarket business, ARB will expand the Midlothian, Texas distribution centre from 4,000sqm to 10,000sqm in December 2024.
- ARB has also leased a small distribution centre in Los Angeles, California to support eCommerce sales and the ORW business in California.

## SEATTLE RETAIL



- Seattle retail site is on hold while we focus our US resource on ARB's product presence in the 53 retail stores.
- A decision on the future of the site will be made in the next 12 - 18 months.

**USA sales recovered in H2 FY2024 with a positive outlook for FY2025.**



## AGM UK TRUCKMAN

ARB's UK Truckman business produced an excellent financial result recovering from a challenging FY23 due to low vehicle registrations.

UK vehicle registrations recovered to historical levels in FY24 as did Truckman's sales.

Truckman's eCommerce business has seen consistent growth in the last 12 months, both [www.truckman.co.uk](http://www.truckman.co.uk) and [www.arb.co.uk](http://www.arb.co.uk).

ARB sales through Truckman and the UK market are growing consistently. OEM partnerships such as the Isuzu ARB Hub partnership are supporting both brand and sales growth in the UK.



**Positive outlook in H2 FY25  
as vehicle supply improves.**



**4X4 ACCESSORIES**

### TRUCKMAN (UK) KEY VEHICLE REGISTRATIONS AUSTRALIAN FINANCIAL YEAR

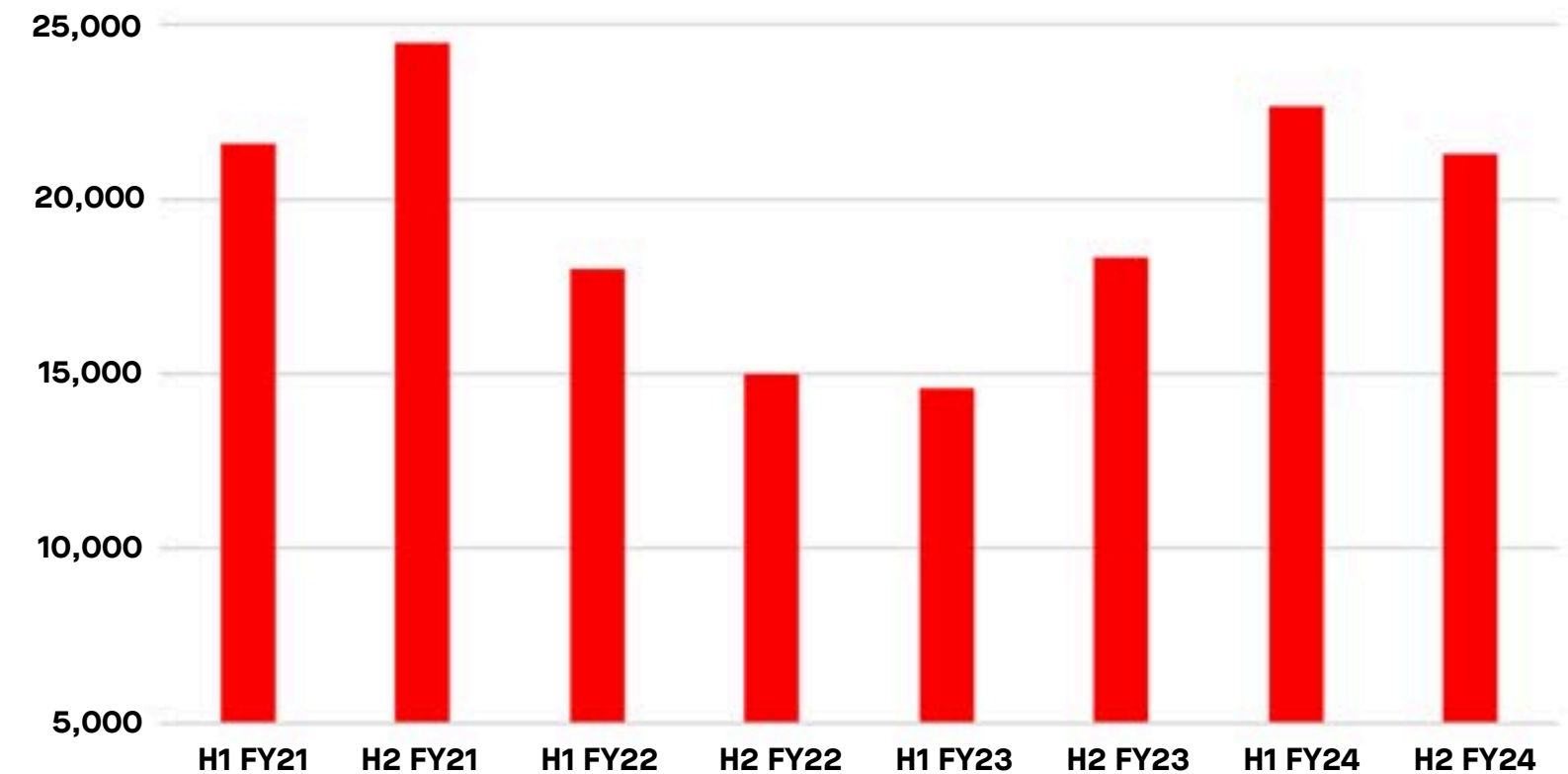

### ISUZU X ARB PRESS INFORMATION

25 APRIL 2024

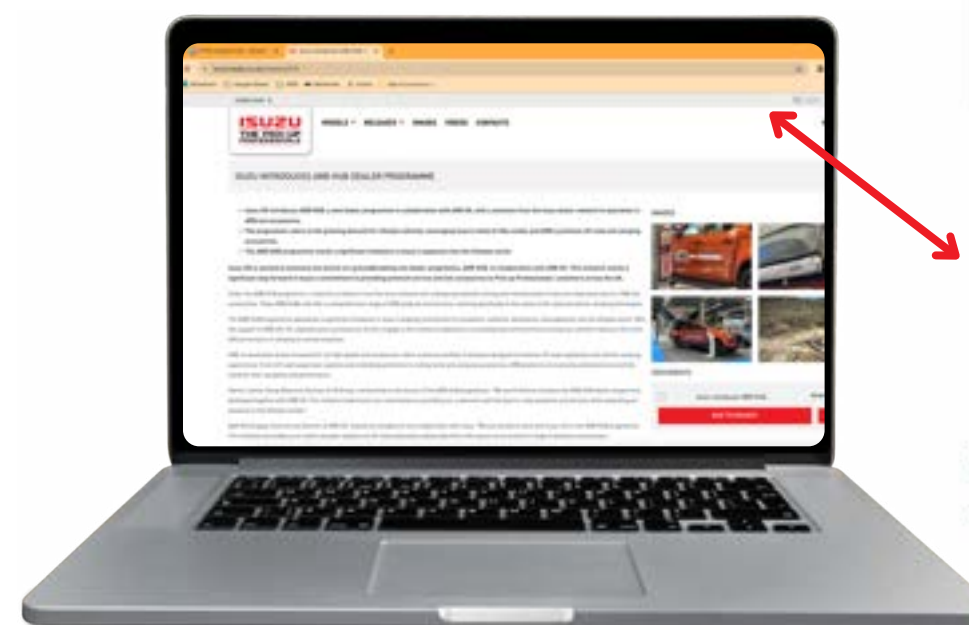

#### ISUZU INTRODUCES ARB HUB DEALER PROGRAMME

- Isuzu UK introduces ARB HUB, a new dealer programme in collaboration with ARB UK, with a selection from the Isuzu dealer network to specialise in ARB 4x4 accessories.
- The programme caters to the growing demand for lifestyle vehicles, leveraging Isuzu's latest D-Max model and ARB's premium off-road and camping accessories.
- The ARB HUB programme marks a significant milestone in Isuzu's expansion into the lifestyle sector.

Isuzu UK is excited to announce the launch of a groundbreaking new dealer programme, ARB HUB, in collaboration with ARB UK. This initiative marks a significant step forward in Isuzu's commitment to



# OUR GOAL

Our goal is to deliver an intuitive & engaging **digital experience** that showcases our products and elevates the ARB brand.

We will **support our existing network** by delivering quotes directly from online and increase foot traffic in store via click and collect programs.

And finally we want to appeal to a new **digitally savvy**, younger demographic of online shoppers.



VEHICLE SELECTOR TO PROVIDE BEST FIT



SAVE & PERSONALISE VEHICLES TO "MY GARAGE"



NEW & IMPROVED PRODUCT CATEGORIES AND SEARCH



IMPROVED PRODUCT CONTENT & PRODUCT PAGES



STORE SELECTOR & TALK TO AN EXPERT MODULE



ABILITY TO QUOTE & BUY ONLINE

## ? What is the current age of the average ARB customer **in-store** VS **Online**

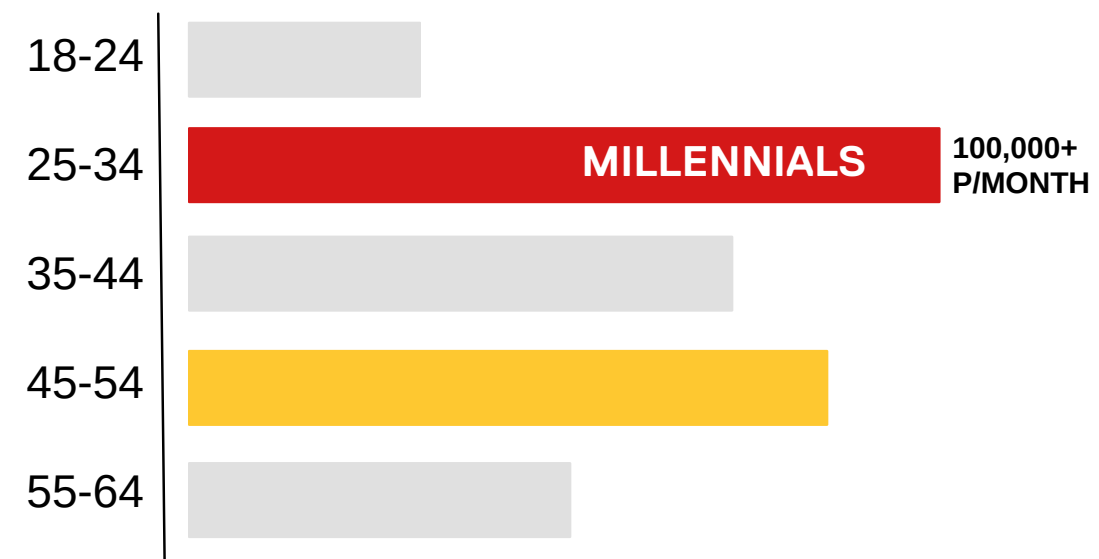





4X4 ACCESSORIES



OEM



# AGM ORIGINAL EQUIPMENT MANUFACTURERS



OEM SALES (\$M)

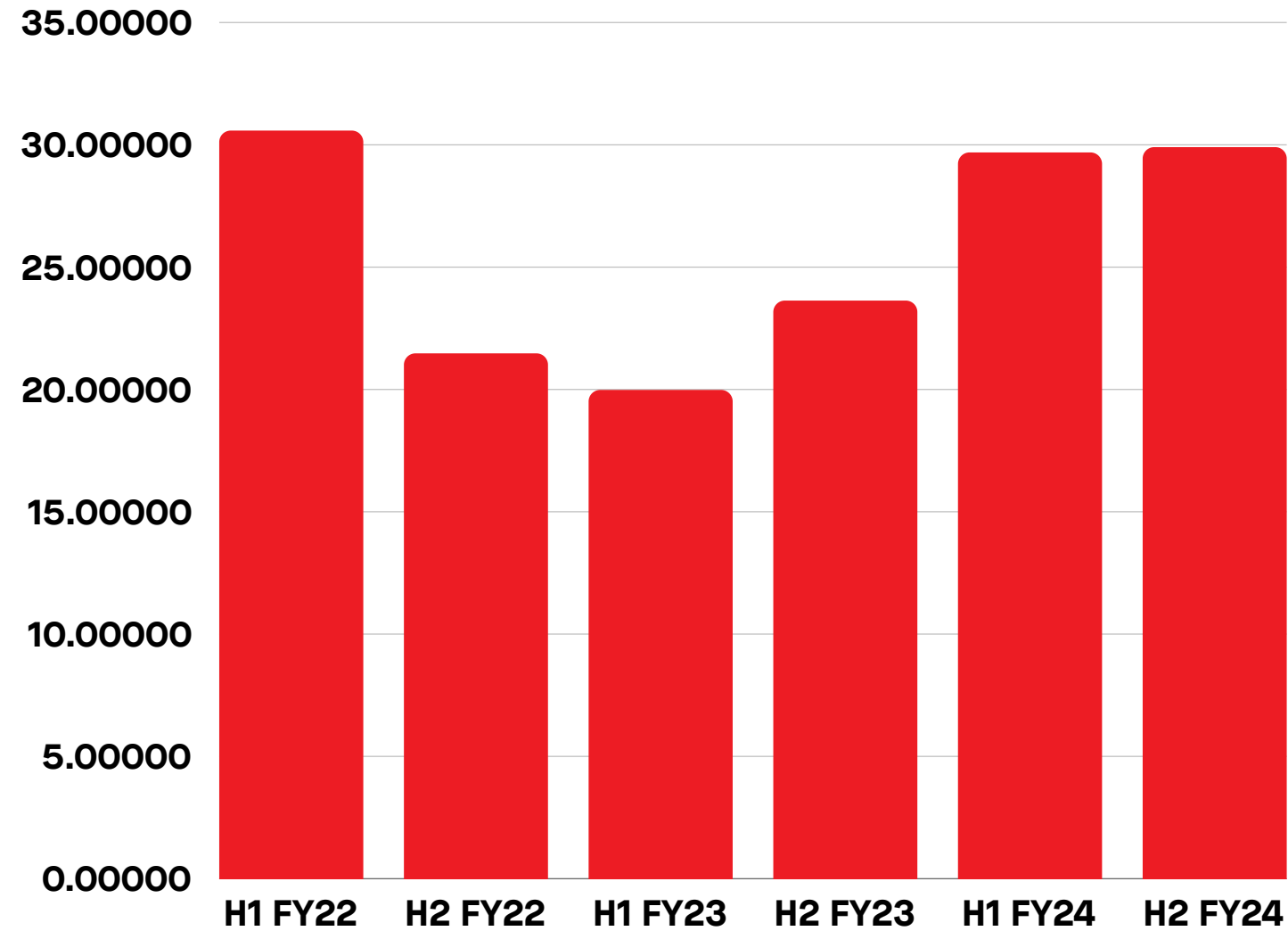

Overall OEM sales improved 40.5% in FY24.

OEM sales represented 8.6% of total sales.

New projects typically have a 2-year to 4-year development cycle. ARB has a record number of projects currently underway for OEMs in Australia and overseas.

Sales to OEMs are forecast to grow in FY25, noting that sales to Toyota USA for the Trailhunter business will be recorded as a USA sale.

New contracts with Toyota USA will be announced during FY2025.







4X4 ACCESSORIES



# PRODUCTS



**AGM BACK OF UTE**



**UTE LIDS**



**CLASSIC CANOPY**



**ASCENT CANOPY**



**ALLOY TRAY & CANOPY**







**4X4 ACCESSORIES**

**MITTS  ALLOY**

EXPLORE WITH NO LIMITS





## AGM MITS ALLOY ACQUISITION

# MITS STORY & EVOLUTION

- MITS Alloy was born from demand for durable trays and canopies, for tough environments.
- MITS Alloy employs around 50 staff and is based in Newcastle, NSW which has dedicated design engineering, manufacturing and installation facilities.
- Founder and Managing Director, Tim Lightfoot, will be retained in the business, lead the future development of MITS Alloy products and support the integration to ARB's store network.



X MITS  ALLOY  
EXPLORE WITH NO LIMITS



# WHAT MAKES MITS BETTER

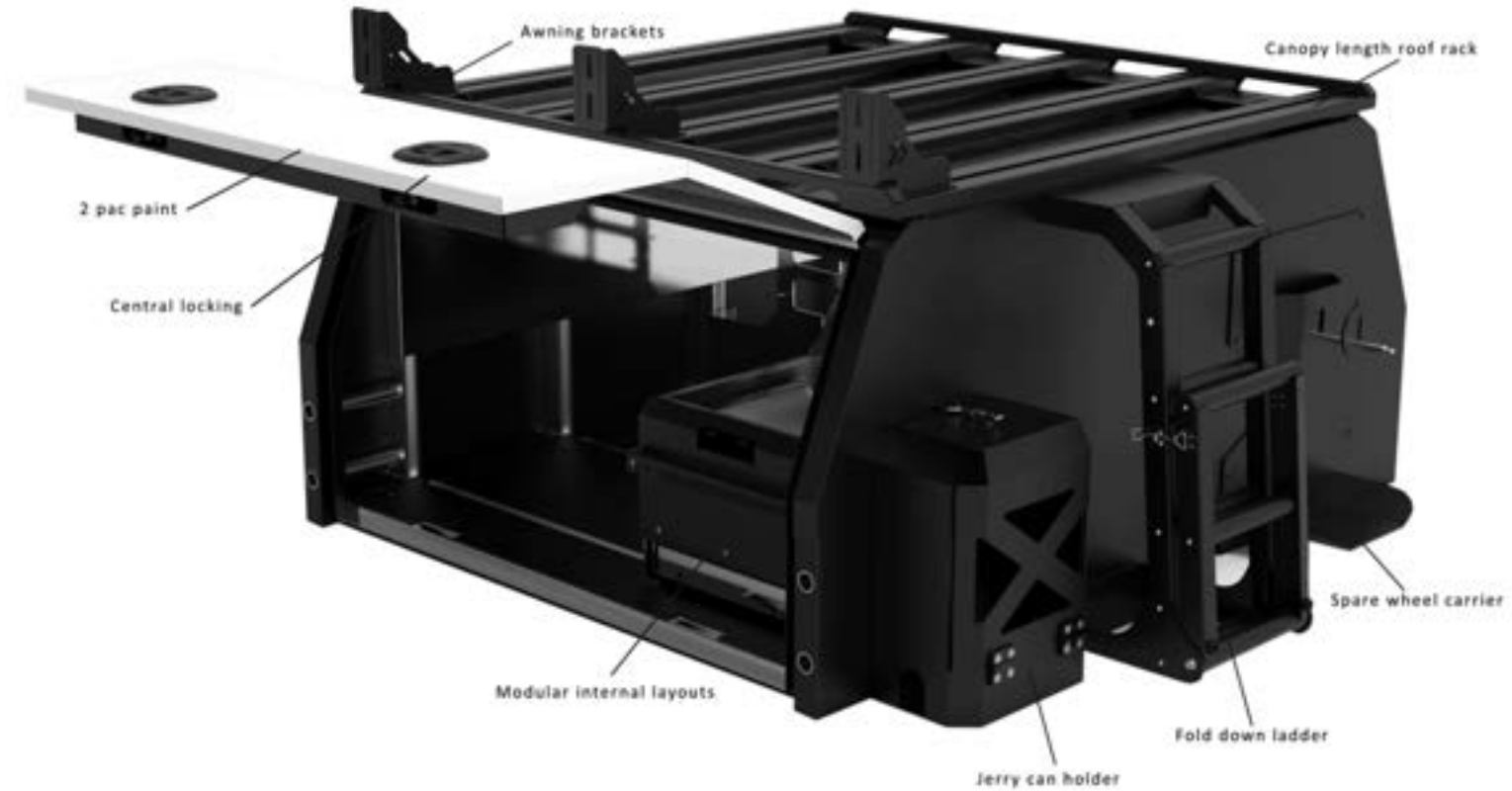

- Australian Made
- Modular
- Standard Sizing
- Extensive R & D
- Customer Service

- Asset purchase agreement signed. Sale due for completion 18 October 2024.
- 5-year earn out in place.
- Integration to the ARB store and wholesale network to commence immediately.
- New product roadmap well developed.
- International expansion, including USA, supports exciting potential growth prospects.





**OLD MAN  
EMU**



**ARB**







BEST OF THE BEST  
**BP-51**

OLD MAN EMU | **ARB**  
[www.arb.com.au/bp-51](http://www.arb.com.au/bp-51)

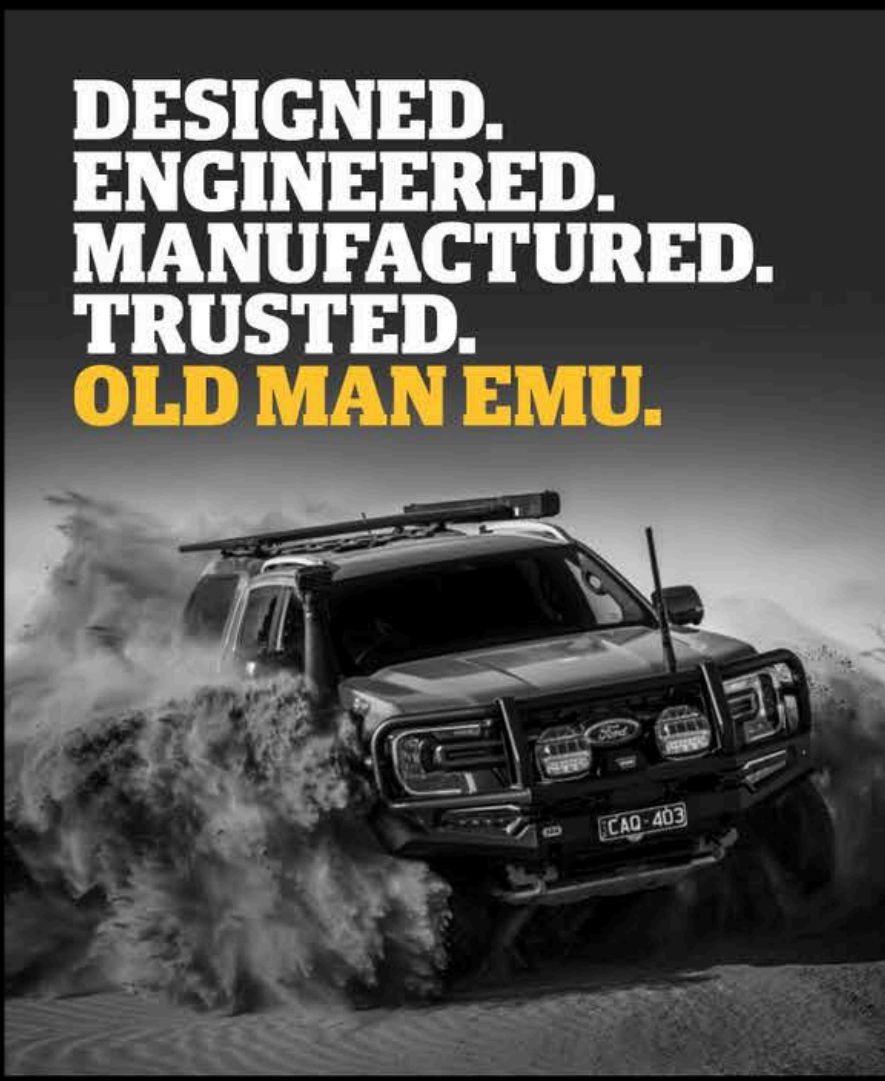

**DESIGNED.  
ENGINEERED.  
MANUFACTURED.  
TRUSTED.  
OLD MAN EMU.**

The only suspension choice. Visit [www.arb.com.au/ome](http://www.arb.com.au/ome) to find out more about our suspension offerings.

OLD MAN EMU | **ARB**

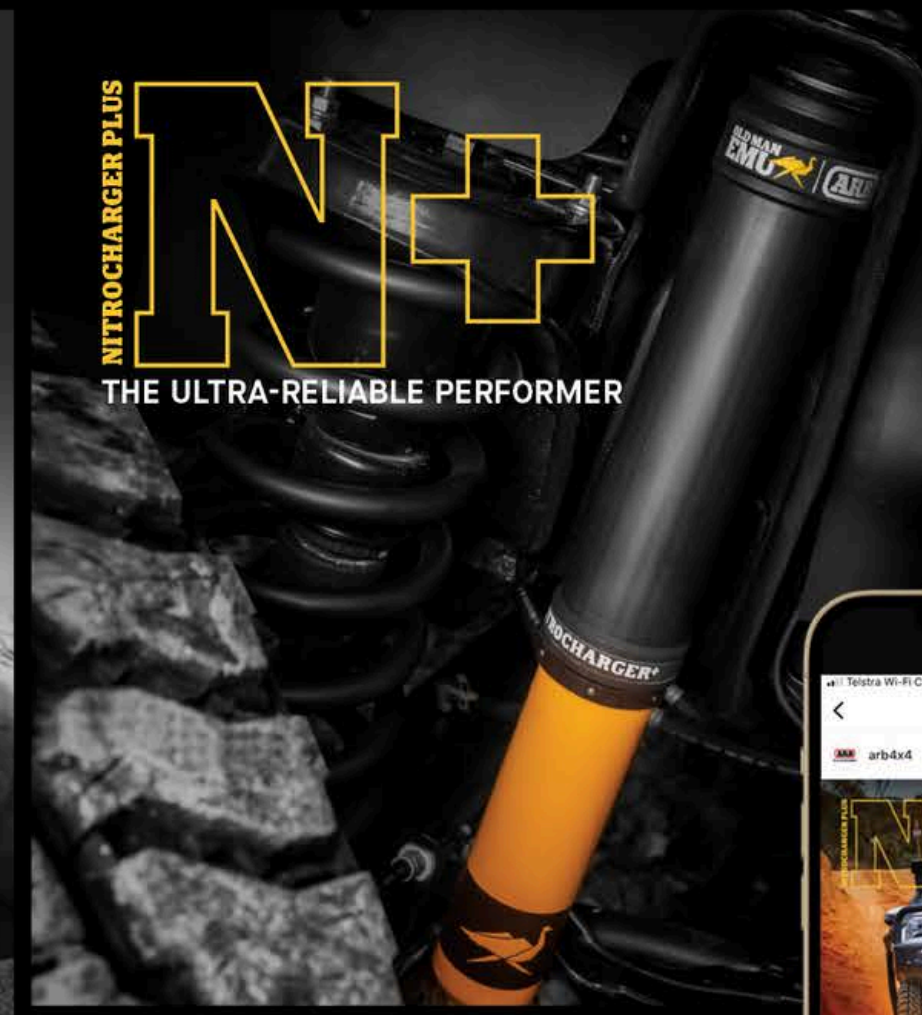

**NITROCHARGER PLUS**  
**N+**  
THE ULTRA-RELIABLE PERFORMER

OLD MAN EMU | **ARB**  
[www.arb.com.au/nitrocharger](http://www.arb.com.au/nitrocharger)

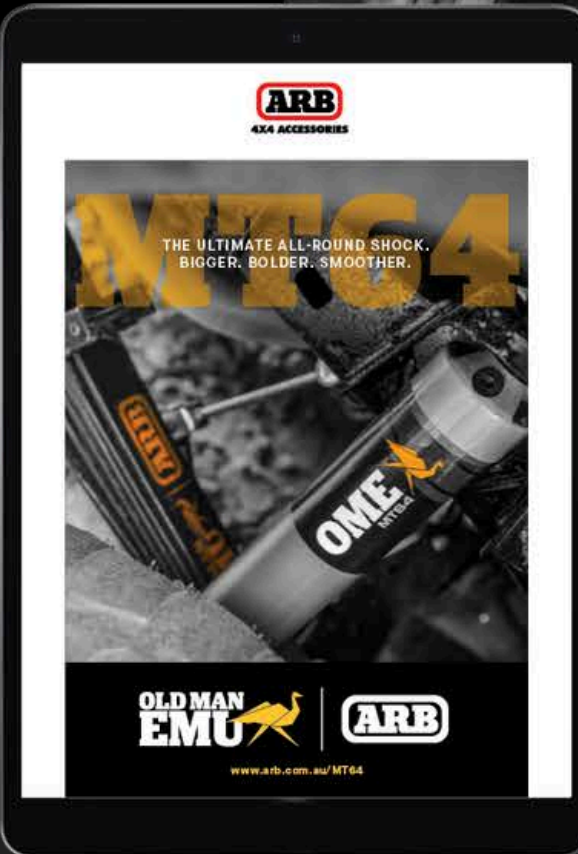

**ARB**  
4X4 ACCESSORIES  
**MT64**  
THE ULTIMATE ALL-ROUND SHOCK.  
BIGGER. BOLDER. SMOOTHER.  
OLD MAN EMU | **ARB**  
[www.arb.com.au/MT64](http://www.arb.com.au/MT64)

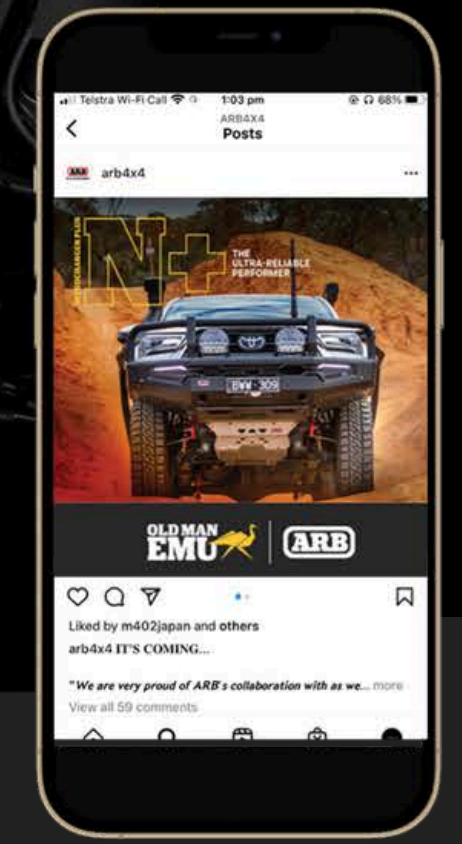

- Industry leading shock absorber line-up. Nitrocharger Plus, MT-64, BP-51.
- Best in-class spring range including new air-bag and parabolic leaf springs.
- Globally recognized integrated suspension solution.
- Market share opportunity in Australia, USA and other international markets.
- Targeted sales and marketing plan in FY25.



## AGM Q1 FY25 UPDATE



- Sales growth of 6.5% was achieved in Q1 FY25 including:
  - 5.5% growth in Australian Aftermarket sales,
  - 2.0% decline in sales to OEMs,
  - 10.4% growth in Export sales.
- Gross margins achieved in Q1 FY25 remain healthy with a small price increase implemented on 1 October 2024.
- ARB's profit after tax in Q1 FY25 is modestly down compared with Q1 FY24. The business is managing labour resources in a dynamic environment, incurred transaction costs and is supporting investments relating to various new strategic initiatives.
- ARB's cash balance has grown to \$62m at the end of Q1 FY25 from \$56.5m at June 2024, sufficient to fund the recent acquisitions. Stock has marginally increased largely as a result of the Toyota USA contract.





## AGM OUTLOOK

- ARB's Aftermarket order book remains strong despite pressure on the Australian economy from cost of living increases.
- Increased fitting output, new store development and new product releases are expected to help off-set lower vehicle deliveries.
- ARB's Export order book has increased in Q1 FY25. It is expected that the acquisition of 4WP by ORW will provide an uplift in ARB sales increasing over time. Further sales growth in the US is expected as a result of contracts with Toyota USA.
- Improving trading conditions in key export markets including USA, New Zealand and United Kingdom.
- Sales to OEMs (excluding Toyota USA) are expected to be stable for the remainder of FY25.

**The Board believes that the Company is well-positioned to achieve long-term success through:**

**Improved USA distribution through the strategic acquisition of 4WP with ORW.**

**Expansion of the Australian Aftermarket with new and upgraded retail stores and stockists with ecommerce on the horizon.**

**Increased distribution and manufacturing capacity to accommodate future growth.**

**A pipeline of new product developments and releases.**

**A well balanced global management team with a blend of long-term ARB and experienced external executives.**







**4X4 ACCESSORIES**

**THANK YOU**

